

# Installation Instructions

**MATTIRA**

**Digital Modulating Electric Boilers**

**For Central Heating And Domestic Hot Water**

---

MAC15C



Please read these instructions carefully before installing or using this appliance for the first time.

**ELNUR** powered by  
**Gabarrón**

# INDEX

<b>1</b>	<b>Important</b>	<b>3</b>	<b>6</b>	<b>Operating The Boiler</b>	<b>24</b>
<b>2</b>	<b>Safety</b>	<b>3</b>	6.1	Initial Switching On	<b>24</b>
<b>3</b>	<b>Introduction</b>	<b>3</b>	6.2	Control Panel Description	<b>24</b>
3.1	Design & Operation	<b>3</b>	6.3	Domestic Hot Water Operation	<b>23</b>
3.2	Principle Components	<b>4</b>	6.4	Central Heating Operation	<b>25</b>
3.3	Key To Components	<b>4</b>	6.5	Anti-Freeze Mode	<b>26</b>
3.4	Safety Devices	<b>4</b>	6.6	User Parameters	<b>26</b>
<b>4</b>	<b>Installation</b>	<b>5</b>	6.7	Heating Modulation Feature	<b>27</b>
4.1	General Requirements	<b>5</b>	6.8	Legionella Protection	<b>27</b>
4.2	Unpacking & Contents	<b>6</b>	6.9	Auto Heating Regulation	<b>27</b>
4.3	Location	<b>6</b>	6.10	Blocking The Controls	<b>28</b>
4.4	Dimensions & Connections	<b>6</b>	6.11	Pump Anti-Seize Function	<b>28</b>
4.5	Clearances	<b>7</b>	<b>7</b>	<b>Trouble Shooting</b>	<b>29</b>
4.6	Mounting Bracket	<b>7</b>	7.1	Possible Faults & Solutions	<b>29</b>
4.6	Typical Installation Layout	<b>8</b>	7.2	Overheat Lock-Out & Re-Setting	<b>30</b>
4.7	Water Connections - General	<b>8</b>	7.3	Heating Flow Switch – E3 Error	<b>31</b>
4.9a	Central Heating Connections, Design & Requirements	<b>9</b>	7.4	Checking Rated Heat Output	<b>31</b>
4.9b	Pump Duty	<b>10</b>	<b>8</b>	<b>Main Components List</b>	<b>31</b>
4.9c	Dhw Heating Connections, Design & Requirements	<b>11</b>	<b>9</b>	<b>Maintenance &amp; Care</b>	<b>32</b>
4.10	Electrical Connections	<b>19</b>	<b>10</b>	<b>Environmental Information</b>	<b>32</b>
<b>5</b>	<b>Commissioning</b>	<b>21</b>	<b>11</b>	<b>Technical Data</b>	<b>33</b>
5.1	Installation Parameters	<b>21</b>	<b>12</b>	<b>Declaration Of Conformity</b>	<b>34</b>
5.2	Limiting Boiler Maximum Output	<b>22</b>	<b>13</b>	<b>Product Fiche</b>	<b>35</b>
5.3	Heating System Flushing	<b>23</b>	<b>14</b>	<b>Wiring Diagrams</b>	<b>36</b>
5.4	Heating System Initial Filling	<b>23</b>	<b>15</b>	<b>Warranty</b>	<b>38</b>
5.5	Pump Checking & Venting	<b>23</b>	<b>16</b>	<b>Installation Commissioning Checklist</b>	<b>39</b>
5.6	Filling Domestic Hot Water	<b>23</b>	16.1	Hot Water Storage System	<b>39</b>
5.7	More Installation Data	<b>23</b>	16.2	Central Heating System	<b>40</b>
			16.3	Electrical Installation	<b>41</b>
			<b>17</b>	<b>Maintenance Checklist</b>	<b>42</b>
			<b>18</b>	<b>Service Record</b>	<b>43</b>

## 1.- IMPORTANT

The following installation instructions are intended to guide the competent person throughout the entire installation process.

The boiler's guarantee does not cover any damage caused by non-observance of any of these instructions.

These installation instructions and user's guide must be conserved and given to any new user.

Connections can come loose in transit, and all should be checked before installation.

The symbols used in the text are explained below:



**WARNING** This indication shows the possibility of causing death from electric shock.



**WARNING** This indication shows the possibility of causing death or serious injury.



**CAUTION** This indication shows the possibility of causing injury or damage to properties only.



Symbol for useful information.

## 2 SAFETY

- This appliance is not destined for use by anyone (including children) with reduced physical, sensorial or mental capacities or those who do not know how to use the appliance, unless they are supervised or instructed by a person responsible for their safety.
- Check that the voltage on the indicator plate of the boiler coincides with the voltage of the mains circuit to which it is going to be connected.
- The use of these boilers in the presence of gases, explosives or inflammable objects is prohibited.
- The air inputs and outputs of the boiler ensure its correct operation and protect it from over-heating. They must never be covered.
- This boiler must be disconnected from the mains electricity before carrying out any internal repairs.
- The boiler must be installed in such a manner that the switches or other controls cannot be touched by anyone who is using the bath or shower.

**The installation must be performed in accordance with current IEE Wiring Regulations, Building Regulations, Water Fitting Regulations (England & Wales) or Water Byelaws (Scotland) and all relevant British Standards.**

- This appliance is destined to be permanently connected to a fixed installation. The power circuit of the boiler must incorporate an omni-polar cut-off switch with a separation between the contacts of at least 3 mm.
- The electricity supply circuit must incorporate a Residual-Current Device.
- This boiler must be earthed.
- All the models incorporate different safety elements. If one or more of them are activated, consult the section 7 TROUBLE SHOOTING.
- In time, the presence in the air of smoke, dust and pollution may stain the walls and areas close to the appliance.
- Any improper use is forbidden.
- Do not install the boiler in rooms prone to frost.

## 3.- INTRODUCTION

### 3.1 DESIGN & OPERATION

The Gabarron MATTIRA COMBI boilers are electrically heated combi boilers providing wet central heating through a standard radiator system (or underfloor system with special kit) and domestic hot water (DHW) delivered from an integral unvented store at mains water pressure.

Outputs are from 2 to 15kW. Maximum output can be adjusted to match the heat requirement of the system or the limitations of the incoming available power supply. Operation is possible on three phase 3x400V+N or single phase 230V - 50Hz.

The boilers are designed for internal installation on a suitable wall with consideration for the total weight of the appliance when full.

A digital control panel provides user control to adjust the temperatures of heating and hot water. A power modulation feature automatically adjusts the heating output to the demand to ensure economic operation.

**A suitable external time clock/room thermostat should be fitted (not supplied).**

**An adjustable thermostatic blending valve should be fitted on the hot water supply to ensure a safe and economic supply of hot water (not supplied).**

All components for sealed system central heating are built-in. **A suitable filling loop should be fitted externally to comply with water supply regulations (not supplied).**

Heating and hot water functions will operate independently but not simultaneously, with priority always to hot water production unless this function is not selected.

### 3.2 PRINCIPLE COMPONENTS

- Insulated steel boiler unit with immersed stainless steel elements INCOLOY800.
- 50 L stainless steel domestic hot water store with CFC free insulation and immersed stainless steel elements INCOLOY800.
- Fully integrated electronic control boards featuring temperature control and modulation function, pump over-run, anti-seize and frost protection. Self-diagnostic fault information.
- Sealed system heating components: circulating pump, 6L expansion vessel, auto air-vent, 3 bar relief valve, pressure gauge, water flow switch and temperature limit safety thermostat.
- Unvented hot water components: 7 bar / 90°C P&T valve, 3L expansion vessel and temperature limit safety thermostat.
- Silent TRIAC power switches.
- Digital control board.

### 3.3 KEY TO COMPONENTS

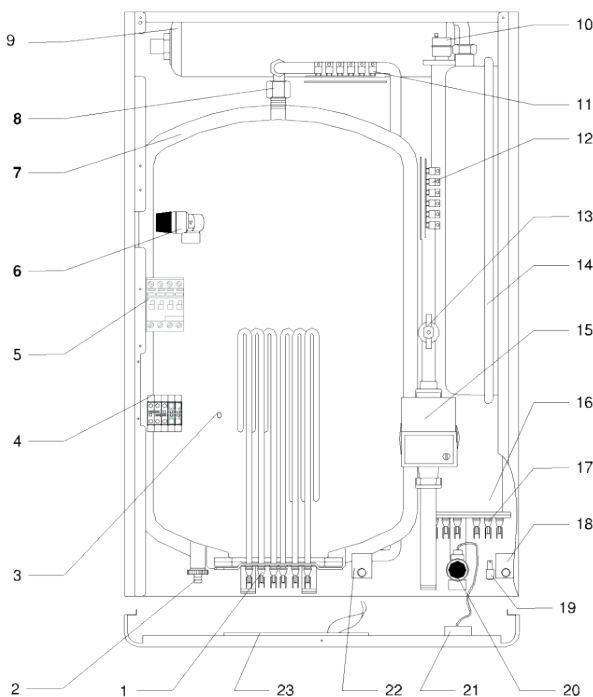

- 1 DHW resistance.
- 2 Drain valve.
- 3 Temperature sensor location.
- 4 Connection block.
- 5 Main contactor.
- 6 DHW 7 bar / 90°C P&T Valve.
- 7 Insulated tank 53L.
- 8 Anti-electrolysis DHW hose.
- 9 DHW expansion vessel 3L.
- 10 Automatic air vent.
- 11 DHW power electronic PCB
- 12 Heating power electronic PCB
- 13 Heating flow detector.
- 14 Heating expansion vessel 6L.
- 15 Circulation pump.
- 16 Insulated heating header tank.
- 17 Heating resistance.
- 18 Heating safety thermal limit switch.
- 19 ON / OFF switch.
- 20 Heating 3 bar relief valve.
- 21 Pressure gauge.
- 22 DHW safety thermal limit switch.
- 23 Main electronic PCB.

### 3.4 SAFETY DEVICES

Safe operation under various conditions is ensured by the following controls fitted inside the boiler:

- Water flow switch that monitors water flow in the heating system and will prevent operation in case of a blockage, if the system flow rate is below the permitted level, error E3 will appear. Installation of a system by-pass may be necessary (see 7.3 HEATING SYSTEM FLOW SWITCH – E3 ERROR & SYSTEM BY-PASS REQUIREMENTS).
- Hot water high limit safety thermostat will prevent operation if the temperature exceeds 80°C. It requires re-setting manually.
- Heating system high limit safety thermostat will prevent operation if the temperature exceeds 100°C. It requires re-setting manually.
- Hot water Pressure and Temperature Relief Valve will discharge to relieve excess pressure at 7 bar and excess temperature at 90°C (Requires piping to a safe external discharge point.)
- Heating system pressure relief valve will discharge to relieve excess pressure at 3 bar. (Requires piping to a safe external discharge point.)

## 4.- INSTALLATION

### IMPORTANT PRE- INSTALLATION POINTS



In order to ensure the successful installation and operation of your Gabarron boiler, please consider the following points before commencing.

### SITING THE BOILER



**WARNING** Wall and fixings must be suitable to support the total weight; MATTIRA MAC boiler when full is **125 kg**.

Allow sufficient clearance and access for operating, maintenance and repair work.

Boiler must be protected from any water, moisture or dampness.

Where installations are in a bathroom, the installation must comply with the relevant electrical regulations.

Boiler electrical protection rating is IP20/IP2X. This boiler is not designed to be installed in the open air.

The boiler must be installed in the upright position.

### ELECTRICAL POWER SUPPLY & WIRING



**WARNING** Before carrying out any work inside the boiler and obtaining access to terminals, all supply circuits must be disconnected.



**WARNING** Earth the appliance. If the appliance is not earthed, it may hold voltage if a defect occurs.

Competency for electrical installation is required.

The power supply must meet the capacity for the heat output required plus all other appliance that may be supplied.

The cable, MCB and RCD must be of sufficient capacity to carry the required load.



Boiler is supplied set at maximum output and must be adjusted to suit the incoming supply before being switched on. (See 5.2 LIMITING BOILER MAXIMUM OUTPUT).

### HEATING SYSTEM & CONTROLS

Any existing system must be suitable for sealed system operation at up to 3bar pressure and will require flushing/cleansing in accordance with the Building Regulations.

Any new heating system must be flushed and cleansed in accordance with the Building Regulations.

A combi filling loop, isolation valves and drain point are required.

A time clock/room thermostat should be installed (Necessary to activate automatic power modulation).

A bypass circuit (min 2m recommended) incorporating an automatic bypass valve must be installed on all central heating systems where TRV's are fitted to every radiator.

**Note - A bypass circuit incorporating an automatic bypass valve is recommended for all installations.**

The correct heat requirement for the dwelling should be calculated.

### HOT WATER SYSTEM

Competency to install unvented hot water systems is required and must be in accordance with section G3 of the Building Regulations (England & Wales), Technical Standard P3 (Scotland) and Building Regulation P5 (Northern Ireland). Compliance can be achieved via a Competent Person Self Certification Scheme or by notification of installation to the Local Authority Building Control Department.

Manufacturer's notes must not be taken as over-riding statutory obligations.

Any existing system and controls (e.g. shower) must be suitable to operate at mains water pressure.

The incoming water main pressure and flow must be sufficient for requirements.

In all installations, the group combination inlet valve (supplied), which incorporates a pressure reducer must be installed on the cold water mains supply to the boiler. The boiler safety valves require piping to a safe discharge point as per the Building Regulations.

In hard water areas it is mandatory to protect the boiler against lime scale formation.

#### 4.1 GENERAL REQUIREMENTS

The installation should be carried out by a person certified as competent for the installation of unvented hot water systems in accordance with current building regulations.

Installation should also be in accordance with the relevant British Standards and Codes of Practice including the following:

BS 5449 Forced circulation hot water systems

BS 5546 Installation of hot water supplies for domestic purposes

BS 6700 Design, installation, testing and maintenance of services supplying water

BS7074 Application, selection and installation of expansion vessels and ancillary equipment for sealed water systems.

BS 7593 Code of Practice for treatment of water in heating systems

BS 7671 Requirements for electrical installations, IEE Wiring Regulations

## 4.2 UNPACKING & CONTENTS

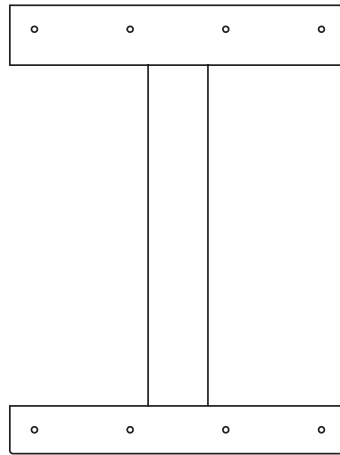
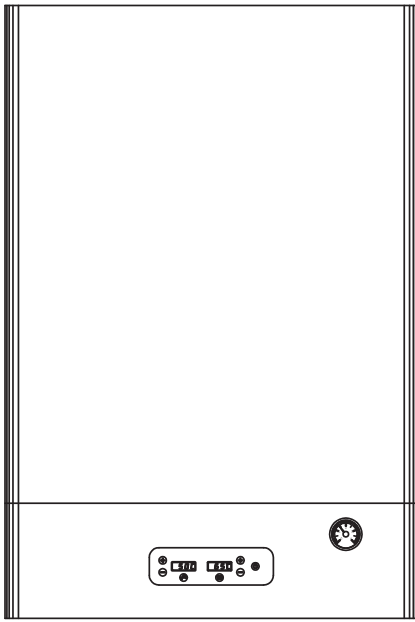

- Wall bracket with template.
- Boiler.
- Documentation.
- Bags with parts and fittings.

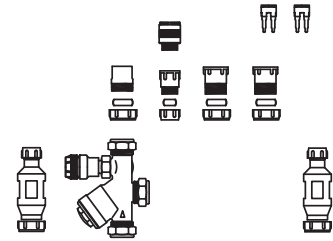

Dispose of the cardboard packaging at a cardboard recycling site. Observe national regulations.

## 4.3 LOCATION



**WARNING** INSTALL UPRIGHT ON A WALL SUITABLE TO SUPPORT THE TOTAL WEIGHT OF THE BOILER WHEN FULL OF WATER – 125 kg.

The location should be clean and dry with no presence of gases, explosives or flammable objects.

It is not suitable for installation outside and should be protected from moisture and frost.

The boiler must be sited so that the boiler and controls are not accessible to any persons whilst using a bath or shower and there should be no possibility of water dripping or splashing onto the boiler or controls.

Electrical safety regulations for clearances must be followed if installed in a bathroom or shower area.

The boiler has an electric protection rating of IP20/IP2X.

Where possible the boiler should be sited to minimize the pipe distance to hot water outlets.

The power supply cable should be carefully routed and secured and provision made for a suitable isolation switch and MCB/RCD.

## 4.4 DIMENSIONS & CONNECTIONS

- A Safety valve drain DHW.
- B Electrical connection
- C Cold water input 1/2"
- D DHW outlet 1/2"
- E Heating return 3/4"
- F Heating flow 3/4"

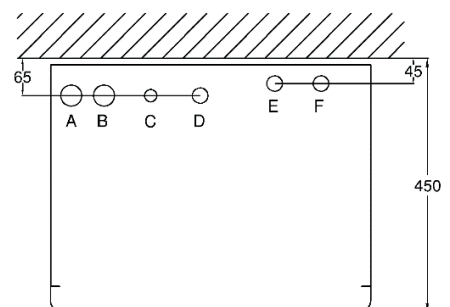
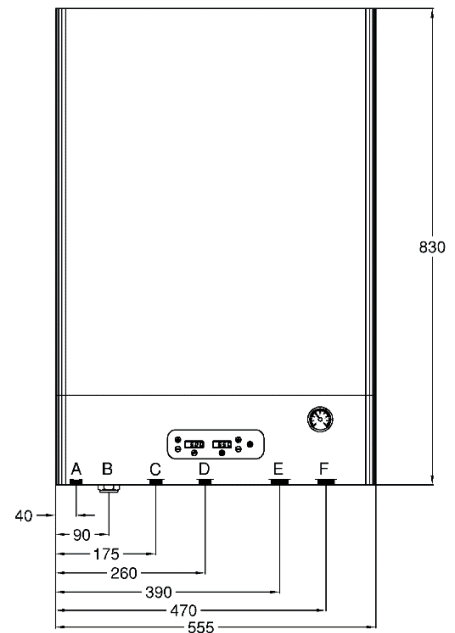

## 4.5 CLEARANCES

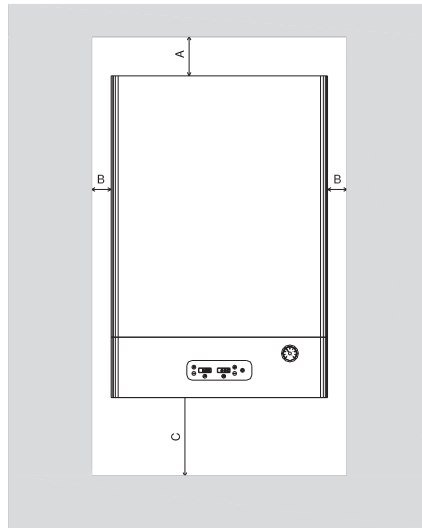

A: 75 mm      B: 10 mm      C: 200 mm

The clearances around the boiler as shown above must be observed for correct operation.

A minimum of 200mm clearance must be maintained underneath the boiler to allow replacement of the heating elements if required. A minimum of 500 mm clearance must be maintained in front of the boiler to enable easy access for servicing. Ensure sufficient space to make all water connections including the outlet pipes for the heating and hot water safety valves which should be routed to a suitable discharge point.

## 4.6 MOUNTING BRACKET

Mark the hole positions using the wall bracket as a template per the diagram.

Fit bracket securely onto wall before lifting appliance into position. Drill the holes and fit the bracket ensuring it is level using suitable high strength screws, with appropriate plugs or fixings, minimum M10 size.

### HANDLING BEFORE INSTALLATION

The Gabarrón Mattira Boiler must be handled with care and stored the correct way up in a dry place. Any manual handling/lifting operations will need to comply with the requirements of the Manual Handling Operations Regulations issued by the H.S.E.

The appliance can be moved using a sack truck on the rear face although care should be taken and the route should be even. In apartment buildings containing a number of storeys we would recommend that the appliances are moved vertically in a mechanical lift. If it is proposed to use a crane, expert advice should be obtained regarding the need for slings, lifting beams etc.

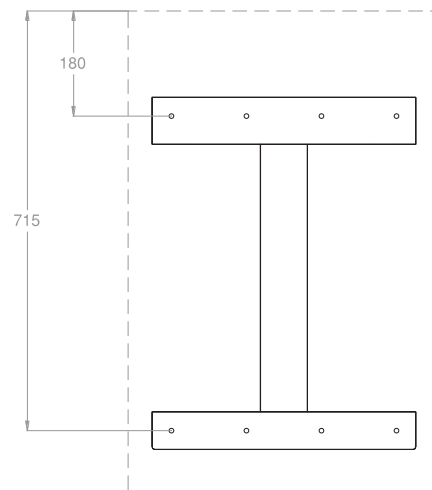

Always use assistance if required. Wear suitable cut resistant gloves when handling the appliance.

Ensure safe lifting techniques are used. Do not lift the appliance by attached pipe-work or components.

When lifting the boiler ensure that the fixing elements and the wall have a sufficient load-bearing capacity. Check the quality of the wall.

#### 4.7 TYPICAL INSTALLATION LAYOUT

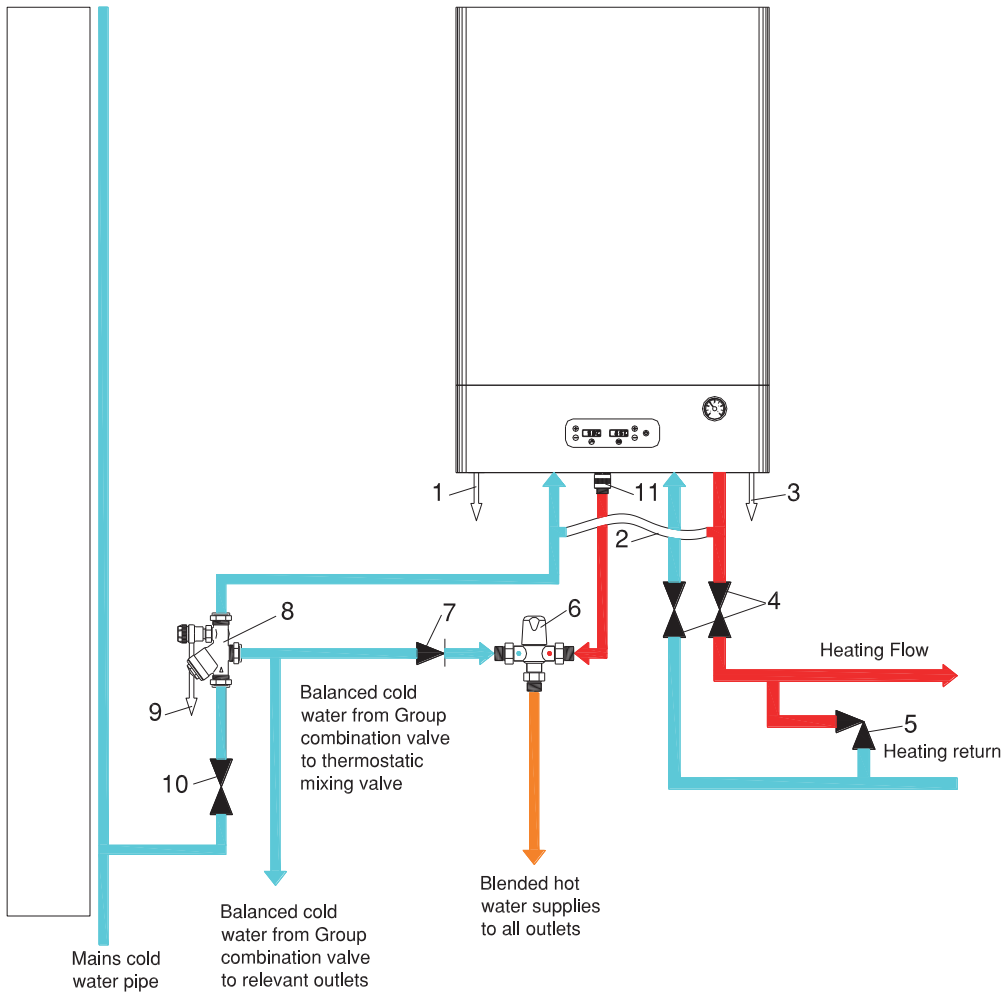

1. DHW P&T Relief Valve (to drain via tundish)
2. Filling Loop
3. Sealed heating system Pressure relief valve (to drain)
4. Full bore isolation valve with drain off above
5. Bypass Circuit incorporating 22mm auto bypass valve
6. Thermostatic mixing valve

7. NRV
8. Group combination valve with drain off above
9. ERV from Group combination valve (to drain)
10. Full bore isolation valve
11. Anti-electrolysis DHW hose.

#### 4.8 WATER CONNECTIONS - GENERAL



**CAUTION** All connections to the boiler must be carried out respecting the correct flow, return, hot, cold and discharge indicators that are labelled on the boiler and also shown in this manual.



**CAUTION** When tightening or loosening threaded connections, always use suitable tools such as open-end spanners. Do not use pipe wrenches, extensions or unsuitable tools that may cause damage or water leaks.



## This boiler is designed for fully pumped sealed systems only.

### Treatment of Water Circulating Systems

All recirculatory water systems will be subject to corrosion unless an appropriate water treatment is applied. This means that the system efficiency will deteriorate as corrosion sludge accumulates within the system. This causes a risk to the pump and valves and can result in boiler noise and circulation problems. When installing heating systems, flux will be evident in the system which can lead to damage of boiler and system components.

All systems must be thoroughly drained and flushed out using corrosion inhibitors and cleansing agents/descalers that are compliant with BS7593 requirements. In all cases, they should be used following the manufacturer's instructions.

Failure to flush and add an inhibitor to the system will invalidate the manufacturer's warranty of the boiler. It is also important that the inhibitor concentration is checked for correctness after installation, modification and during every service in accordance with the relevant manufacturer's instructions. Test kits specifically for this purpose are available from inhibitor stockists.

### Heating Flow & Return

These connections are 3/4" for connection to 22mm pipe using the connection fittings provided. Service valves should be installed in the pipework directly below the boiler with drain-off points above to allow the boiler to be isolated for maintenance without the need to drain the entire system. The valves should be of sufficiently large bore so not to restrict the heating circulation.

The boiler is not suitable for single pipe heating systems, only a twin-pipe heating system should be used.

It is recommended that a **minimum** of 2m of 22mm diameter pipework is present to/from the flow and return connections on the boiler as reduction in size prior to this may result in the system flow rate being below the minimum level required, resulting in error E3.

### Drain Point

As detailed above, drain points should be installed directly above the service valves on the flow and return pipe work to enable the removal of water from within the boiler for servicing and maintenance, preventing the need to drain the entire system.

A drain point must also be fitted at the lowest point of the system. It is not acceptable to drain the boiler through the safety valve as debris and deposits will prevent correct operation of the valve.

### Heating System By-pass

The heating water flow switch requires a minimum flow rate through the boiler of 7 L/min for correct operation. Systems fitted with Thermostatic Radiator Valves on every radiator **must** have a bypass circuit installed.

The bypass circuit must be in 22mm pipe work, is recommended to have at least 2m of continuous pipework and must incorporate an automatic bypass valve. This is required in order to maintain sufficient flow through the boiler should all of the valves be closed. (See 7.3 Heating System Flow Switch - E3 Error & System Bypass Requirements).

To alleviate potential flow issues, especially on smaller systems, it is recommended that all installations be fitted with a bypass circuit as described above.

### System Expansion

An integral 6 L expansion vessel provides for expansion of the heated system water under normal conditions however a system with larger volumes of water may require extra expansion capacity to be provided.

## Filling Loop

A combi filling loop is required for filling of the heating system and replacing water lost during servicing or bleeding and should be installed close to the boiler. The loop should be as shown in the diagram and comply with current Water Supply Regulations. The temporary connection should be removed after filling and the valves sealed with suitable caps.

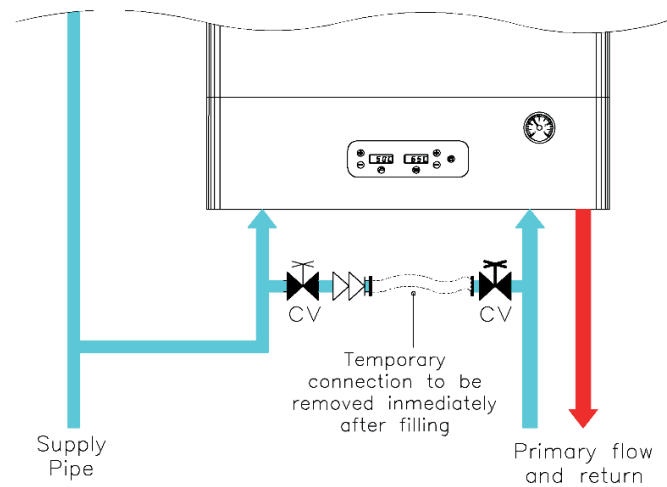

Ensure that all radiators have air release (bleed) valves installed and that high points in pipe work have an air release valve (automatic type recommended) installed.

## Pressure Relief Valve

The pressure relief valve is set at 3 bar, subsequently all fittings and pipework, etc. must be suitable for pressures in excess of 3 bar and temperature in excess of 100°C.

The pressure relief valve has a 1/2" BSP thread for connection via a suitable connector to copper tube and the pressure relief discharge pipe should not be less than 15mm diameter.

The pressure relief discharge pipe must run continuously downward and discharge outside of the building, preferably over a drain.

The discharge pipe should be routed in such a manner that it does not present a hazard to occupants or cause damage to wiring or electrical components.

If the discharge pipe does not terminate over a drain then, the end of the pipe should terminate facing down and towards the wall.

Under no circumstances should the discharge be above a window, entrance or other public access.

The installer must give consideration to the possibility that boiling water / steam could discharge from the pipe.

If the discharge pipe is to join a common discharge pipe, it must have its own tundish and increase to 22mm dia. prior to connection to the common discharge pipe.

If the discharge is to join into the common discharge from an unvented cylinder then, it must follow the guidance of G3 of the Building Regulations.

All installations must be fitted in accordance with all local regulations in force at that time. Failure to comply with these regulations will invalidate the manufacturers' warranty.

## 4.9 (b) PUMP DUTY

Boiler equipped with a high efficiency circulation pump, with a maximum delivery head of 6.2 m and a maximum flow of 3.3 m<sup>3</sup> / h.

There are selectable operation modes with the built-in knob. You can select constant operating speeds I, II and III.

A LED indicator informs about the operating status of the pump

- Green: correct operation.
- Green / red flashing: Lower voltage  $U < 180V$ ; overvoltage  $U > 253V$ ; Module overheating
- Red flashing: pump blocked.

#### 4.9 (c) DHW CONNECTIONS, DESIGN & REQUIREMENTS



**CAUTION:** This boiler incorporates a 53 litres unvented hot water cylinder. Installation of this appliance must be carried out by a Competent Person and in accordance with the relevant regulations.

In every installation it is mandatory for the Group combination valve to be installed on the mains cold water supply to the boiler. This will protect the boiler and prevent constant opening of the 7 bar P&T relief valve (The Group combination valve is comprised of a pressure reducing valve, a pressure relief valve, a check valve, a filter and a balanced cold water outlet all included in a single valve. These inlet control groups are designed to control the pressure on the mains supply to the integral unvented hot water cylinder).

The installation of the thermostatic blending valve (not supplied) is recommended, as per the diagram shown in 4.7 to ensure a safe and economic supply of hot water.

Maximum inlet pressure to Pressure reducing valve	12 Bar (1.2 MPa)
Operating pressure (PRV setting)	3 Bar (0.3 MPa)
Expansion vessel charge pressure	3.5 Bar (0.35 MPa)
Expansion relief valve setting	6 Bar (0.6 MPa)
Opening pressure of P & T Relief Valve	7 Bar (0.7 MPa)
Opening temperature of P & T Relief Valve	90°C
Energy cut-out thermostat setting	80°C
Immersion heater rating	2-15kW depending upon setting
Expansion Relief Valve connection (Inlet Pressure Group)	½ inch.
Drain tap connection	½ inch.
PT Valve connection	½ inch.
Inlet Group Set connections	¾ inch.

All cylinders are manufactured in accordance with the requirements of BS EN 12897.

The tundish must be positioned so that it is visible to the occupant and is away from electrical devices.

#### **Components supplied with Gabarrón Mattira electric combi boiler (incorporating a 53 litre unvented cylinder):**

- Cold water inlet Group Combination Valve (supplied loose)
- Pressure and temperature relief valve
- Control thermostat
- Energy cut-out thermostat
- Tundishes (supplied loose)
- Immersion heaters including control and cut out thermostats
- Expansion vessel
- Technical/user product literature

**In any situation where the volume of heated pipework (eg. secondary circulation pipes or manifold pipework for multiple units) exceeds 10 litres, then an additional expansion vessel must be fitted to accommodate the extra expansion volume.**



**CAUTION:** Modifications should not be made to this product. Replacement parts, including immersion heaters, should be purchased from Elnur UK Limited, or agents approved by them.

Unvented hot water storage vessels need regular routine checks, and these are detailed below. It is for this reason that this manual must always be left with the Gabarrón Mattira combi boiler.

It is essential that these checks be carried out at the time of boiler maintenance by a qualified installer:

1. Manually open the relief valves in turn, and check that water is discharged from the valves and runs freely through the tundish and out at the discharge point. Ensure that the valves re-seat satisfactorily. (Note – the water may be very hot).
2. It is important to check that the discharge pipework is carrying the water away adequately. Check for blockages etc. if it is not.
3. Turn the mains water off and remove and clean the strainer element in the Pressure Reducing Valve.

4. Check the charge pressure in the expansion vessel and repressurise if required.
5. Re-fill the system and ensure that all relief valves have re-seated.
6. The Service Record should be updated at each service.
7. Check the water pressure downstream of the combination valve is 3 bar in static condition.
8. Check and if necessary, descale the heat exchanger in hard water areas ie. above 200ppm (mg/l).

**Note:**

The cylinder is factory fitted with a temperature & pressure relief valve that must not be used for any other purpose or removed.

The cylinder is factory fitted with immersion heaters with thermal cut outs. Immersions without thermal cut outs must not be fitted.

Gabarrón Mattira combi boilers incorporate an unvented hot water storage cylinder, manufactured in the latest high quality duplex stainless steel. They are designed to provide mains pressure hot water and are supplied as a package which complies with Section G3 of the Building Regulations. The appliance is extremely well insulated using high density HCFC free foam insulation with an ozone depleting potential (ODP) of zero and a global warming potential (GWP) of 1. It is fitted with all necessary safety devices and supplied with all the necessary control devices to make installation on site as easy as possible. An endoscope can be used on the connections or the immersion heaters can be removed to inspect the internal of the cylinder. The immersion heaters boss can be used as an access to view internal of the cylinder.

**The Gabarrón Mattira combi boiler with integral unvented cylinder is available in one variant:**

**I. Gabarrón Mattira combi boiler c/w Integral Direct Unvented Cylinder** - For providing central heating and hot water heated by electricity.

Gabarrón Mattira combi boiler incorporates an electrically heated, unvented hot water storage cylinder designed primarily for use with on peak electrical supplies. It is supplied fitted with **3 x 3kW & 3 x 2kW** immersion heaters which are CE approved for safety.

**Heat Up Recovery Times**

Please refer to section 11 TECHNICAL DATA

**Typical Layout**

Please refer to section 4.7 TYPICAL INSTALLATION LAYOUT

**Part G3 loose components supplied in boiler box**

A. Combination inlet group incorporating pressure reducing valve, strainer, check valve, balance cold take off point, expansion relief valve and expansion vessel connection points (expansion vessel connection point blanked off in normal installation as boiler has integral expansion vessel incorporated).

B. Tundish

**Pipework to be supplied and fitted by installer.**

## General Design Considerations

The wall chosen for the boiler should be level and capable of supporting the weight of the unit when full of water as shown in **Section 4**. The discharge pipework for the safety valves must have a minimum fall of 1:200 from the unit to a safe discharge point. All exposed pipework and fittings on the boiler should be insulated, and the unit should NOT be fixed in a location where the contents could freeze.

In new systems, pipes should be insulated to comply with building regulations, the maximum permissible heat loss is indicated in the table below, and labelled accordingly as follows:

- i. Primary circulation pipes for domestic hot water circuits should be insulated through their length, subject only to practical constraints imposed by the need to penetrate joists and other structural elements.
- ii. All pipes connected to hot water storage vessels, including the vent pipe, should be insulated for at least 1 metre from their points of connection to the cylinder (or they should be insulated up to the point where they become concealed). In replacement systems, whenever a boiler or hot water storage vessel is replaced in an existing system, any pipes that are exposed as part of the work or are otherwise accessible should be insulated as recommended for new systems or to some lesser standard where practical constraints dictate.

Pipe outside diameter	Maximum heat loss
15mm	7.89W/m
22mm	9.12W/m
28mm	10.07W/m
35mm	11.08W/m

Insulation of pipework

Further guidance on converting heat loss limits to insulation thickness for specific thermal conductivities is available in TIMSA “HVAC guidance for achieving compliance with Part L of the Building Regulations”.

**The Gabarrón Mattira combi boiler is designed for use with single bathroom properties only and is capable of a delivery up to 12 L/min hot water flow rate.**

### Mains Water Supply

Existing properties with a 15mm supply will be satisfactory provided the local mains pressure is good. For new properties, the communication and service pipe into the dwelling should be a minimum of 22mm (usually in the form of a 25mm MDPE supply). The optimum performance is achieved if the inlet pressure is 3 bar dynamic. However, the Gabarrón Mattira combi boiler will function with lower inlet pressures, but this will reduce the performance. For optimum performance, 15 L/min incoming mains flow should be present; however the Gabarrón Mattira combi boiler will work at lower flow rates, although performance will be affected. Normally, the Gabarrón Mattira combi boiler provides in excess of 10 L/min in most conditions. Flow rates for ALL mains pressure systems are subject to district pressures and system dynamic loss. Particularly on larger properties, the pipe sizes should be calculated in accordance with BS EN 806-3:2006 and BS 8558:2011.

### Mains Water Connection

A ½” BSP thread is provided on the boiler for connection to the incoming mains cold water supply. A 1/2" x 22mm connection fitting is supplied to join the pipe work to the boiler connection. The installation of a full bore isolation valve on the mains water supply to the boiler is required (in close proximity to the boiler location). An internal non-return valve within the Group combination valve prevents possible back-flow should the water main fail.

## General Restrictions

- a. The highest hot or cold water draw off point should not exceed 10m above the Pressure Reducing Valve.
- b. An ascending spray type bidet or any other appliance with a Class I back-syphonage risk requiring a type A air gap should not be used.
- c. The Gabarrón Mattira combi boiler is only designed to be a self-contained unit powered by electric via the main incoming terminal block and not by or in conjunction with any other system or source.
- d. The Gabarrón Mattira combi boiler should not be used in a situation where maintenance is likely to be neglected.
- e. If the supply to the mixer fittings (other than a dual outlet type) is not taken from the balanced supply the system will become over pressurized and cause the pressure relief valve to discharge. Over time this could also cause the premature failure of the appliance itself which will not be covered by the warranty.
- f. In larger properties with a number of bathrooms/en-suites (not a recommended installation option) and/or long pipe runs, we would recommend that the balance cold supply is provided with its own pressure reducing valve and is not taken from the balanced cold connection on the combination valve. In this case, it will also be necessary to fit a small expansion vessel on the balanced cold water system to accommodate the pressure rise caused by the increase in temperature of the balanced cold water.
- g. Check the performance requirements of the terminal fittings with regard to flow/pressure are suitable.
- h. In relation to potable water systems, additional expansion vessels, if required, shall be installed in a vertical orientation and located so that the length of the connecting pipe work is kept to a minimum.

## Shower Fittings

Aerated taps are recommended to prevent splashing. Any type of shower mixing valve can be used as long as both the hot and cold supplies are mains fed. However, all mains pressure systems are subject to dynamic changes particularly when other hot and cold taps/showers are opened and closed, which will cause changes in the water temperature at mixed water outlets such as showers. For this reason and because these are now no more expensive than a manual shower we strongly recommend the use of thermostatic showers with this appliance. These must be used in 3 storey properties where the impact on pressure/temperature of opening another tap in the system is greater than normal. The shower head provided must also be suitable for mains pressure supplies and **not** of high flow rate design in excess of 15 L/min mixed flow rate.

## Pipe Layout

In all mains pressure installations it is important to remember that the incoming cold supply must be shared between all terminal fittings. It is important that a 22mm supply is brought to the appliance. A minimum of one metre of smaller diameter pipework, or flow restrictors, should be provided on the final connection to all outlets so as to balance the water available. In any event the distribution pipework should generally be in accordance with BS\_EN806-1 to 5.

## Plastic Pipework

This appliance is suitable for use with plastic pipework as long as the material is recommended for the purpose by the manufacturer and is installed fully in accordance with their recommendations.

## Note:

Cold supplies to single taps must be taken from the mains cold water system.

Cold supplies to mixer taps must be taken from the balanced cold water connection on the Group combination valve.

## Hot Water Outlet

A ½" connection is provided for connection to 15mm pipe. To ensure economic operation the pipe run between the boiler and taps should be in not more than 15 mm dia. pipe and the distance as short as possible. The pipe-work should be insulated to reduce heat loss.

The anti-electrolysis DHW hose provided must be installed first of all on the hot water outlet.

A 1/2" x 15mm connection fitting is supplied to join the pipe work to the boiler connection.

The installation of the hot water outlet pipe should be in accordance with 4.7 TYPICAL INSTALLATION LAYOUT

## Discharge Pipework



### CAUTION: Safety Valve Connections

The 7 bar pressure relief valve on the domestic hot water store may discharge boiling water and should be piped to a safe but visible drain point e.g. a gully where any discharge will not cause damage or injury.

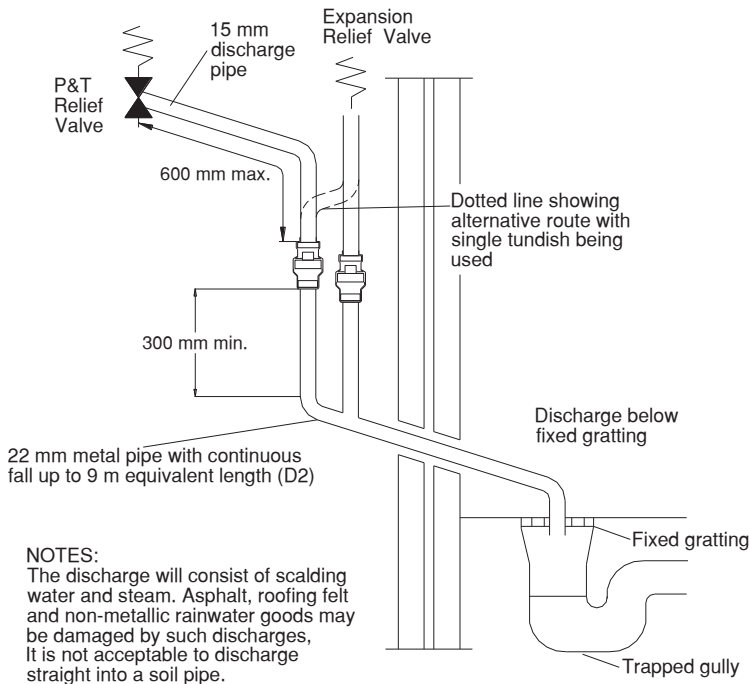

## Typical Discharge Pipe Arrangement



**CAUTION:** A tundish (supplied) should be incorporated close to the appliance where any discharge will be visible but not hazardous. The pipe-work should have a continuous fall to the drain and should be of minimum 28mm dia. In all instances, installation of the discharge pipework must be in accordance with G3 of the Building Regulations and installed by a Competent Person.

The information below is taken from Approved Document G3 of the Building Regulations and is provided to assist with the design and installation of the discharge pipework. However, the information is not exhaustive and reference should always be made to Approved Document G3 of the Building Regulations. The final decision regarding any arrangements rests with Building Control and it is recommended that their advice is sought if you have any concerns regarding this aspect of the installation.

The two safety valves will only discharge water under fault conditions. When operating normally water will not be discharged.

**Table 1 – Sizing of copper discharge pipe “D2” for common temperature relief valve outlet sizes**

Refer to paragraphs 3.5, 3.9, and 3.9(a) of Approved Document G

Valve Outlet Size	Minimum size if discharge pipe D1*	Minimum size of discharge pipe D2* from tundish	Maximum resistance allowed, expressed as length of straight pipe (i.e. no elbows or bends)	Resistance created by each elbow or bend
G1/2	15mm	22mm	Up to 9m	0.8m
		28mm	Up to 18m	1.0m
		35mm	Up to 27m	1.4m
G3/4	22mm	28mm	Up to 9m	1.0m
		35mm	Up to 18m	1.4m
		42mm	Up to 27m	1.7m
G1	28mm	35mm	Up to 9m	1.4m
		42mm	Up to 18m	1.7m
		54mm	Up to 27m	2.3m

## Pressure & Temperature/expansion Relief Valve Pipework

The tundish should be vertical, located in the same space as the unvented hot water storage system and be fitted as close as possible and within 600mm of the safety device e.g. the temperature relief valve. The tundish must be positioned away from any electrical devices.

The discharge pipe (D2) from the tundish should terminate in a safe place where there is no risk to persons in the vicinity of the discharge, be of metal (or a material capable of conveying water/steam at 100°C) and:

- a) Be at least one pipe size larger than the nominal outlet size of the safety device unless its total equivalent hydraulic resistance exceeds that of a straight pipe 9m long, i.e. discharge pipes between 9m and 18m equivalent resistance length should be at least two sizes larger than the nominal outlet size of the safety device, between 18 and 27m at least 3 sizes larger, and so on. Bends must be taken into account in calculating the flow resistance. Refer to the table and the worked example.  
An alternative approach for sizing discharge pipes would be to follow BS EN 806-2:2005 Specification for design installation, testing and maintenance of services supplying water for domestic use within buildings and their curtilages.
- b) Have a vertical section of pipe at least 300mm long, below the tundish before any elbows or bends in the pipework.
- c) Be installed with a continuous fall.
- d) It is preferable for the discharge to be visible at both the tundish and the final point of discharge but where this is not possible or practically difficult there should be clear visibility at one or other of these locations. Examples of acceptable discharge arrangements are:
  1. Ideally below the fixed grating and above the water seal in a trapped gully.
  2. Downward discharges at a low level; i.e. up to 100mm above external surfaces such as car parks, hard standings, grassed areas etc. are acceptable providing that where children play or otherwise come into contact with discharges, a wire cage or similar guard is positioned to prevent contact whilst maintaining visibility.
  3. Discharges at a high level; e.g. into metal hopper and metal down pipe with the end of the discharge pipe clearly visible (tundish visible or not) or onto a roof capable of withstanding high temperature discharges of water and 3m from any plastic guttering systems that would collect such discharges.
  4. Where a single pipe serves a number of discharges, such as in blocks of flats, the number served should be limited to not more than 6 systems so that any installation can be traced reasonably easily. The single common discharge pipe should be at least one pipe size larger than the largest individual discharge pipe to be connected. If unvented hot water storage systems are installed where discharges from safety devices may not be apparent i.e. in dwellings occupied by blind, infirm or disabled people, consideration should be given to the installation of an electronically operated device to warn when discharge takes place.

## Safety

The safety devices supplied or fitted on an Gabarrón Mattira combi boiler are selected for their suitability for the temperatures and pressures involved. They must not be changed, removed or by-passed and it is essential that only genuine replacement parts supplied or approved by Elnur UK Limited are used. This includes the immersion heaters, which must incorporate an energy cut-out. All parts are available to approved installers from Elnur UK Ltd.

## Combination Inlet Group Combines elements 1, 2 and 3 below.

1. Pressure Reducing Valve - This must be fixed near the cylinder. The cold water supply to any mixer taps/showers must be taken from the cold water tapping of this valve to ensure balanced hot and cold pressures. This valve is factory set to ensure the correct operating pressure for the Gabarrón Mattira combi boiler.
2. Non Return Valve - This is integral with the pressure reducing valve to prevent backflow of hot water towards cold water draw off points.
3. Cold Water Expansion Relief Valve - This safety device is preset at the factory and will relieve excess cold water pressure resulting from a fault condition.

## Immersion Heaters

These are 3x3kW plus 3x2kW 240V~ heaters and incorporate a thermostat and a manually reset energy cut-out which operates at 80°C. They have incoloy elements to prolong their life expectancy in aggressive water conditions. The control thermostat of the immersion heaters for direct heating of our cylinders can be set up to 60°C. During commissioning the actual temperature that the cylinder reaches when the thermostat(s) operate should be tested and adjusted so that it achieves a minimum of 60°C. This temperature needs to be achieved on a regular basis.



## Line Strainer

This is integral within the combination inlet group to reduce the likelihood of contaminants fouling the valve seat. Following installation this line strainer must be cleaned and replaced. This needs to be carried out on a regular basis as part of the annual maintenance/service check.

## Safety

The immersion heaters are indirectly supplied power via the main boiler terminal block which must be earthed. The main power supply to the boiler must be isolated from the mains before the cover is removed on every occasion. Replacement immersion heaters should be obtained from Elnur UK Ltd.

## Important

Failure to follow the drain down procedure will invalidate the warranty.

### **NEVER drain the cylinder of hot water and then close all cylinder inlets and outlets**

REASON: As the air remaining in the cylinder cools the pressure inside the cylinder will fall below atmospheric and cause damage to the cylinder.

### **NEVER close the cold main and drain the cylinder via any tap connected to it.**

REASON: As the air remaining in the cylinder cools the pressure inside the cylinder will fall below atmospheric and cause damage to the cylinder.

## Fitting Blending Valves (thermostatic mixing valves) To the Gabarrón Mattira combi boiler

When fitting a blending valve to the unvented appliances, it is important that the installation does not contravene the G3, WRC and Health and Safety directives or the manufacturer's recommendations. If this is the case, then the warranty should be null & void. The key requirements to comply with these regulations are:

1. Any fitting or material in contact with potable water (e.g. a blending valve) must be approved by WRC or an equivalent body.
2. Connections or wiring arrangements must not bypass any safety devices.
3. Any expansion due to heating must not be allowed to expand back into the cold mains.
4. The settings of any safety devices must not be tampered with or adjusted.

4.7 TYPICAL INSTALLATION LAYOUT shows the cold water port of the blending valve connected to the balanced cold water outlet. This arrangement will only be acceptable if a WRAS approved non-return valve is fitted, otherwise, during the heating cycle, the water will expand back into the mains supply, as the regulating valve must not be relied upon to act as a check valve under all operating conditions.

Depending upon the characteristics of the blending valve, hot water may also flow from the balanced cold water taps.

It is not permitted for the cold water port of the blending valve to be connected to the mains cold water supply before the inlet control group. This arrangement is completely unacceptable and illegal because the water is allowed to expand in to mains cold water supply, the vessel will be charged to the incoming mains supply which may be considerably higher than the working pressure of the vessel.

## Installation Checks

Check the pressure on the air side of the expansion vessel = 3 bar. This must be done when the water in the cylinder is free to expand in atmospheric pressure or the cylinder and relevant pipe work is empty.

Check that the drain cock is closed, and open all the cold and hot water taps and other terminal fittings. Allow the system to fill with water, and to run until there is no air left in the system. Close the taps and inspect the system closely for leaks.

Manually open the Relief Valves one by one and check that water is discharged and run freely through the tundish and out at the discharge point. The pipework should accept full bore discharge without overflowing at the tundish, and the valve should seat satisfactorily.

In line with good plumbing practice, use with excessive flux should be avoided. When soldering close to the boiler, ensure flux/solder does not contaminate the cylinder inside, since this can cause corrosion. Flushing should be done performed as per BS EN 806:4 2010 section 6.2.

Allow the cylinder to heat to normal working temperature, then thoroughly flush the domestic hot and cold water pipework through each tap.

NOTE: If this appliance is to be installed in other than a single domestic dwelling ie. in an apartment block or student flats etc., the hot and cold water system will need to be disinfected in accordance with BS\_EB 806:4 2010 section 6.3 and the Water Regulations.

Because the Gabarrón Mattira combi boiler cylinder is stainless steel, the use of chlorine as the disinfection agent can cause damage unless the appliance is adequately flushed and refilled with the mains water immediately on completion of the disinfection procedure.

Damage caused through a failure to do this adequately will not be covered by the warranty.

## IMPORTANT - DRAIN DOWN PROCEDURE

1. Switch off both the boiler and the immersion heater
2. Open the nearest hot tap and run all hot water until cold, then close it
3. Close the incoming cold main at the stop tap
4. Hold open the pressure and temperature relief valve until water stops discharging into the tundish and leave it open
5. Open the cold taps starting from the highest point and working down to the lowest tap, leaving them open
6. When the cold taps have stopped draining, open the hot taps starting from the highest and working down to the lowest tap
7. Any water remaining in the internal cylinder can then be removed via the cylinder drain point inside the boiler housing

## Commissioning

For the reasons mentioned, we recommend the use of a non-chlorine based disinfectant when carrying out disinfection of systems incorporating these appliances.

Remove the filter from the combination inlet group clean and replace. Refill the system and open all hot taps until there is no air in the pipe work. ENSURE CYLINDER IS DRAINED PRIOR TO CHECKING OR REMOVING FILTER FROM THE COMBINATION INLET GROUP.

Allow the cylinder to heat to normal working temperature, and check again for leaks. The pressure relief valve or the P&T valve should not operate during the heating cycle. If the P&T valve operates before the pressure relief valve due to high pressure, check that the inlet control group is fitted correctly.

The boiler/heating systems should be filled and commissioned in accordance with good practice following the guidance in BS 7593:2006/the boiler manufacturer's instructions. This includes adequately flushing the system to remove any debris that may have been introduced during installation/maintenance.

## NOTES

At the time of commissioning, complete all relevant sections of the **Checklist** located on the inside back pages of this document.

This must be completed during commissioning and left with the product to meet the Warranty conditions offered by Elnur UK Ltd.

Your Gabarrón Mattira combi boiler incorporating an unvented cylinder is automatic in normal use, but requires routine maintenance which is normally carried out at least annually along with the boiler service.

The maintenance must be carried out by a suitably competent tradesperson who is qualified to work on unvented cylinders. The checks/work needed are listed in the maintenance part of these Instructions.

During commissioning the actual temperature that the cylinder reaches when the thermostat(s) operate should be tested and adjusted so that it achieves a minimum of 60°C, in order to comply with the Legionella pasteurization requirements.

When initially opening the taps, a small surge in flow may be experienced, which disappears as the pressure in the system stabilizes. This is quite normal with these types of systems and does not indicate a fault.

In some areas, the water will initially appear cloudy, but will quickly clear when left to stand. This is nothing to be concerned about and is due to aeration of the water.

**WARNING** - If water is seen flowing through the tundish, this indicates a fault condition which needs action. If the discharge is hot and continuous, turn the boiler and/or the immersion heaters off, but do not turn off the cold water to the appliance until the discharge is cold. Note: The discharge may stop by itself as the discharge cools. If the discharge is cold and intermittent, no immediate action is needed but this indicates a problem with the expansion vessel.

However, in both cases you must call the registered installer / a suitably qualified, competent tradesperson, advise them that you have an unvented cylinder and request a maintenance visit.  
DO NOT, at any time, tamper in any way with the safety valves or overheat thermostats/wiring.

#### 4.10 ELECTRICAL CONNECTIONS

##### **Connection to Mains Supply**

The GABARRÓN MATTIRA COMBI MAC15C boilers must be installed in premises having a system impedance of not more than  $0.25 + j0.25\Omega$ .

The GABARRÓN MATTIRA COMBI MAC15C boilers comply with the technical requirements of BS EN 61000-3-3.

The GABARRÓN MATTIRA COMBI MAC15C boilers must be installed in premises having a service capacity  $\geq 100$  A per phase.

Complete all the pipe-work before connecting the boiler to the electricity supply.

Any re-installation must be performed by qualified electricians.

Ensure that the mains voltage available coincides with that shown on the rating label.



**WARNING** IMPORTANT: CHECK THAT THE TOTAL POWER SUPPLY TO THE BUILDING HAS SUFFICIENT LOAD CAPACITY TO SUPPLY THE BOILER AT THE HEAT OUTPUT REQUIRED IN ADDITION TO ALL OTHER APPLIANCES THAT MAY BE SUPPLIED.



**WARNING** THE SUPPLY CABLE TO THE BOILER SHOULD BE OF SUFFICIENT SIZE TO CARRY THE LOAD CAPACITY REQUIRED. IT SHOULD BE WIRED THROUGH A LINKED ISOLATOR SWITCH WITH MINIMUM CONTACT GAPS OF 3mm IN EVERY POLE AND PROTECTED BY A SUITABLY RATED CIRCUIT BREAKER MCB/RCD. Install the necessary electrical protections as indicated in the current regulations. In the event of these regulations not being complied with, the manufacturer will not be liable for any bodily injury or material damage that may occur.



**WARNING** IT IS ESSENTIAL THAT THE BOILER IS PROPERLY EARTHED and the wiring tested to current IEE regulations.

## Electrical Supply Sizing

The following table shows the specification for a boiler installed on single phase supply.

Rated output of boiler	4kW	5kW	6kW	7kW	8kW	9kW	10kW	11kW	12kW	13kW	15kW
Supply current	17.4A	21.7A	26.1A	30.4A	34.8A	39.1A	43.5A	47.8A	52.2A	56.5A*	65.2A*
MCB / RCD rating	20A	25A	32A	32A	40A	50A	50A	50A	63A	63A	80A
Minimum cable size	2.5mm	4mm	4mm	6mm	6mm	10mm	10mm	10mm	16mm	16mm	16mm

\* The standard configuration of the boiler only allows a maximum of 12kW when connected SINGLE-PHASE 230V~.

## Connection to Boiler



**WARNING** Touching live connections can cause serious personal injury.

Before establishing a mains connection switch off the power supply. Secure the power supply against being switched on again. Mains connection terminals remain live even if the on/off switch is turned off.

The boiler is delivered ready for operation on 3x400V three phase supply. For operation on 230V single phase the supplied links must be connected across the terminals of the connection block as shown.

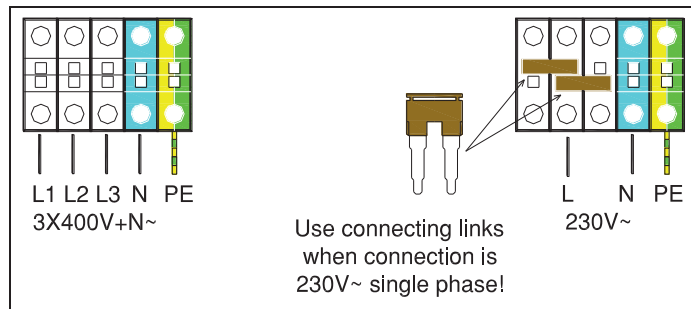

Three phase and single phase connection

The terminal connection block is located mid-way up at the front left hand side of the boiler and is accessed after removing the boiler front panel. The supply cable should be routed to this point through the cable entry point on the left hand bottom of the boiler.



**CAUTION:** A mains voltage at the incorrect plug terminal can destroy the electronics.



Make sure the connecting cables are securely fastened to the plug terminals.

## Wiring External Controls

It is recommended that the boiler is controlled by an external control such as a time clock or room thermostat or a combined programmable room thermostat such as the Elnur model CTP-10.



**CAUTION:** The switching connection of this control should be VOLT FREE and connected to the terminals indicated 'TA' on the PCB. The factory fitted link across these terminals must be removed.



The boiler's automatic power modulation feature is ONLY activated by the initial interruption of this switching link.



## 5.- COMISSIONING

### 5.1 INSTALLATION PARAMETERS





These parameters must be adjusted by the installer to match the requirements of the installation.

To access to installation parameters menu:

- Ensure the rear mounted power on/off switch is turned on.
- Ensure the main display front panel is turned off by using the  button.
- Press and hold the  and  buttons together for at least 5 seconds.

To move forward or backward through the menu use the  and  buttons respectively.

To modify a parameter:

- Select the appropriate value e.g. -P00, P01, P02, etc.
- Press the  button to display the current setting.
- Modify the setting as required using the  and  buttons.
- To confirm the new setting, press the  button once.

After setting the various parameters it is necessary to validate by pressing the  button for 3 seconds.

**Note - If this is not done after completing changes, none of the changes made will be saved.**

**IMPORTANT** - If none of the buttons are pressed for 30 seconds, the installation parameter menu will be automatically closed without validating/saving any changes.

**P00**

**Boiler type.** If the boiler is for central heating and Domestic Hot Water (DHW) this parameter is 1. If the boiler is only for central heating it will be 0.

**P01**

**Model.** 15 corresponds to model MAC15C.

**P03**

**Boiler maximum output limit.**  
**MAC15C can be limited to 15 - 13 - 12 - 11 - 10 - 9 - 8 - 7 - 6 - 5 - 4 - 3 - 2 kW.**

**P04**

**Underfloor heating.** If the boiler is underfloor heating ready this parameter will be 1 otherwise it will be 0.

**P05**

**Outdoor temperature probe.** An outdoor temperature probe (not provided) can be installed. In this case the parameter value will be 1.

**P06**

**Heating temperature differential.** The heating temperature differential can be selected from 2°C to 10°C. The default value is 2°C.

**P07**

**DHW temperature differential.** The DHW temperature differential can be selected from 2°C to 8°C. The default value is 2°C.

**P08**

**Modulation.** 1 (modulation ON)  
0 (modulation OFF).

**P09**

**Units.** °C (Celsius)  
°F (Fahrenheit).

**P10**

**Legionella.** 1 (Legionella protection ON)  
0 (Legionella protection OFF).

To access the parameters menu from **P11 – P15**, an outdoor temperature probe must be installed and the parameter in **P05** set to 1

**P11**

**AUTO heating regulation.** If a fan outdoor temperature probe is installed it is possible to activate the auto heating regulation by shifting this parameter value to 1.

**P12**

**TIMAX.** Maximum water flow temperature in AUTO heating mode.

**P13**

**TIMIN.** Minimum water flow temperature in AUTO heating mode.

**P14**

**TEMAX.** Outdoor temperature from which the water flow temperature will be TIMIN.

**P15**

Parameters menu from **P16 – P18** are only accessible for DHW & central heating boiler (P00=1).

**P 16**

**ECO SMART.** 1 (Eco Smart function ON)  
0 (Eco Smart function OFF).

**P 17**

**TCON.** Maintenance consumption connection time. Factory pre-set.

**P 18**

**TSCON.** Time interval between maintenance consumption. Factory pre-set.

## 5.2 LIMITING BOILER MAXIMUM OUTPUT

The boiler is supplied for operation on maximum heat output of 15kW. The output can be rated below this maximum to match the heat load required. This rating is done by means of P03 parameter. See above "5.1 INSTALLATION PARAMETERS"



**WARNING:** ON INSTALLATIONS WHERE THE INCOMING POWER SUPPLY IS NOT CAPABLE OF MAXIMUM LOAD THE BOILER CONTROL MUST BE RE-CONFIGURED TO LIMIT THE OUTPUT BEFORE SWITCHING ON.

As the output for Domestic Hot Water will also be limited to the same level it is recommended to adjust to the highest output possible so as to maintain the best hot water performance.

The boiler will not exceed this pre-set maximum but will still modulate in heating mode up to this level, adapting to demand and ensuring economic operation.

Correct configuration for the selected output can be checked on the boiler display panel following the procedure shown in 7.4 CHECKING RATED HEAT OUTPUT.



**CAUTION:** It is essential to confirm the power output with the use of a clamp meter.

### LIMITATION OF OUTPUT ON MODELS MATTIRA COMBI MAC15C

Maximum output limited to:	MAXIMUM CURRENT L1	MAXIMUM CURRENT L2	MAXIMUM CURRENT L3	Maximum output limited to:	MAXIMUM CURRENT
15kW	21.7A	21.7A	21.7A	15kW*	65.2A*
13kW	21.7A	21.7A	13.0A	13kW*	56.5A*
12kW	8.7A	21.7A	21.7A	12kW	52.2A
11kW	21.7A	13.0A	13.0A	11kW	47.8A
10kW	13.0A	8.7A	21.7A	10kW	43.5A
9kW	13.0A	13.0A	13.0A	9kW	39.1A
8kW	13.0A	8.7A	13.0A	8kW	34.8A
7kW	8.7A	13.0A	8.7A	7kW	30.4A
6kW	8.7A	8.7A	8.7A	6kW	26.1A
5kW	8.7A	13.0A	-	5kW	21.7A
4kW	-	8.7A	8.7A	4kW	17.4A
3kW	13.0A	-	-	3kW	13.0A
2kW	-	-	8.7A	2kW	8.7A

CONNECTION THREE-PHASE 3x400V~+N

CONNECTION SINGLE PHASE 230V~

\* The standard configuration of the boiler only allows a maximum of 12kW when connected SINGLE-PHASE 230V~.

### 5.3 HEATING SYSTEM FLUSHING



**CAUTION:** Flush the heating installation thoroughly prior to installation.

The heating system should be flushed in accordance with BS7593 & BS5449 which will remove any debris or contaminants detrimental to the operation and life of the boiler. Any cleanser or additives used should comply with current standards and the manufacturer's instructions carefully followed.

**NOTE:** IT IS IMPORTANT NOT TO USE THE BOILER PRESSURE RELIEF VALVE TO DRAIN OR FLUSH THE SYSTEM AS TRAPPED DEBRIS WILL CAUSE INCORRECT OPERATION. A PURPOSE PROVIDED DRAIN POINT SHOULD BE USED.

### 5.4 HEATING SYSTEM INITIAL FILLING

Ensure both flow and return isolation valves are open. Identify the boiler automatic air release valve at the top right hand side of boiler and loosen the cap. Close any manual air vents fitted on the system.

Be careful not to splash any of the electrical components.

Connect the filling loop and fill slowly until the pressure gauge indicates between 1 and 1.5 bar.

Proceed to vent all the manual release valves until all air is purged from the system. It will be necessary to top-up through the filling loop during this operation until the pressure gauge indicates between 1 and 1.5 bar.

### 5.5 PUMP CHECKING & VENTING

Sometimes (i.e. if display fault E3) it is necessary to check that the pump is properly vented and spinning freely.

To purge the pump, turn on the boiler and with the pump selector, alternate between positions III and Min every fifteen seconds. Keep this operation for 5 minutes. If excess air remains in the system or there is insufficient pressure or flow rate the boiler will fail to operate and display fault E3.

A LED indicator informs about the operating status of the pump:

- Green: correct operation.
- Green / red flashing: Lower voltage  $U < 180V$ ; overvoltage  $U > 253V$ ; Module overheating
- Red flashing: pump blocked.

### 5.6 FILLING DOMESTIC HOT WATER

Open the mains water inlet valve underneath the boiler. Turn on all the hot water system taps and thoroughly flush allowing water to flow until no air is present. This will automatically vent the integral hot water store of any air.

### 5.7 MORE INSTALLATION DATA

It is possible to display more installation data by pressing  for a few seconds and then  or .



Heating return temperature.



Maximum output limitation in kW.



Modulated output in kW.



Outdoors temperature. (Only if the sensor is connected and P005 is activated).

## 6.- OPERATING THE BOILER

### 6.1 INITIAL SWITCHING ON



**CAUTION:** THE MAXIMUM HEAT OUTPUT MUST BE ADJUSTED BEFORE SWITCHING ON. THE BOILER SHOULD NEVER BE SWITCHED ON WITH THE HEATING SYSTEM OR DHW TANK EMPTY. DAMAGE COULD OCCUR.



When the boiler is first connected it will perform a general self-check and if a fault is detected it will be indicated on the display.

Turn on the boiler with the on/off switch located at the back of the boiler as shown.

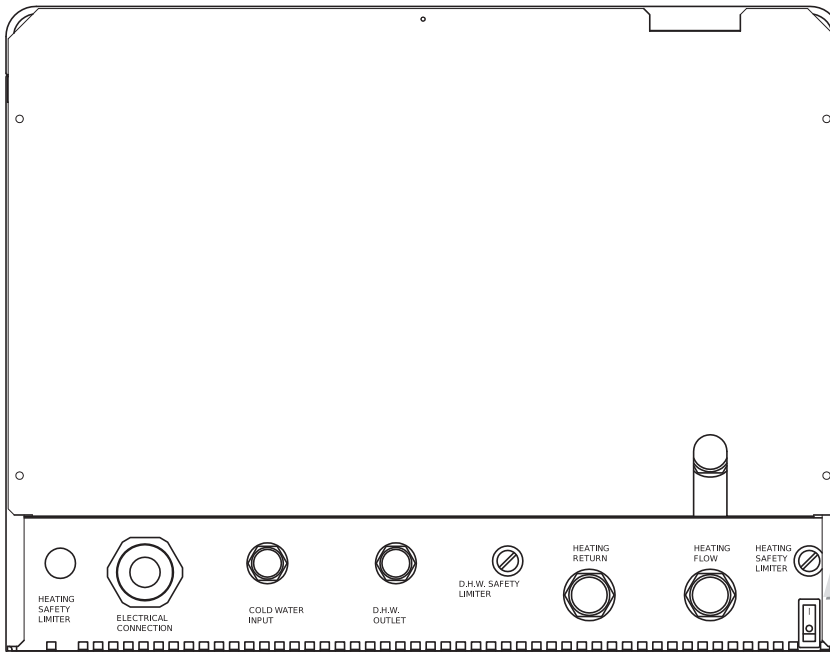

**CAUTION:** MAINS CONNECTION TERMINALS REMAIN LIVE EVEN IF THE ON/OFF SWITCH IS TURNED OFF.

### 6.2 CONTROL PANEL DESCRIPTION

#### MATTIRA COMBI MAC15C

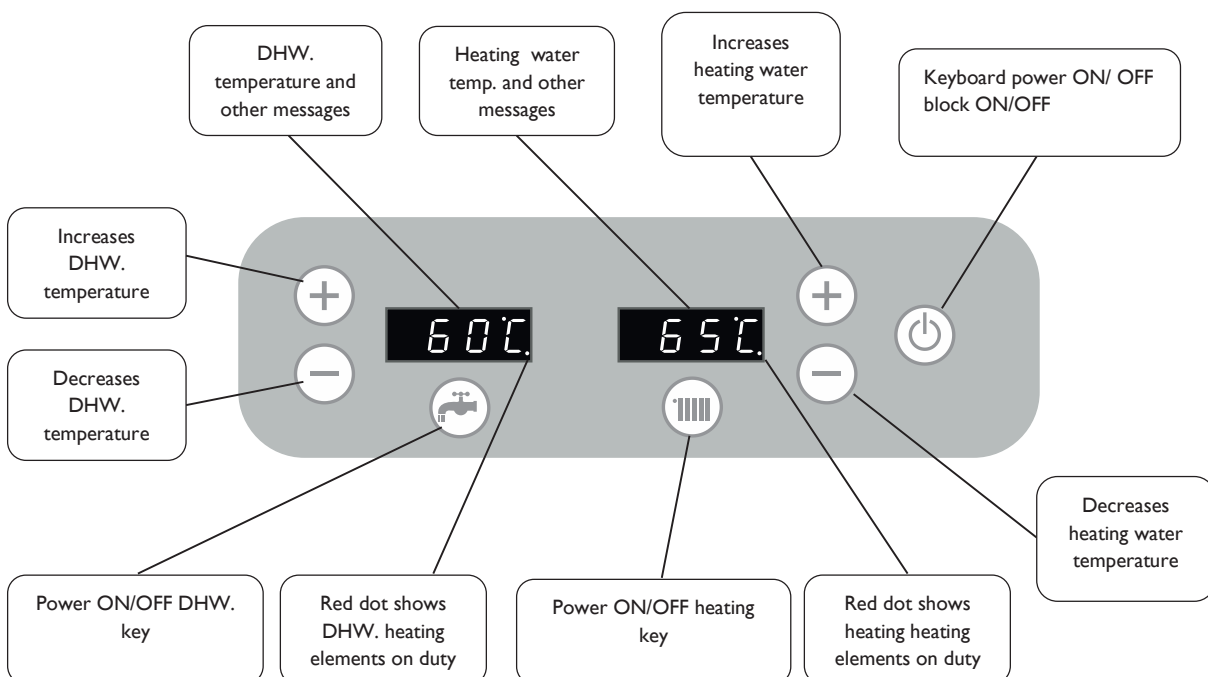



Push the  button to start the boiler up. The same button will turn the boiler off when pushed again.

If the heating or DHW function are not selected the relevant screen will not display a value but just a red dot. 

### 6.3 DOMESTIC HOT WATER OPERATION

To select the DHW function push the  button. Pushing again will switch the function off and return display to just a red dot.





When the DHW mode is selected the display will show the actual temperature in the DHW accumulation tank. The boiler will always give priority to DHW production over central heating until the selected DHW temperature is reached.

If heat is demanded by the DHW and the elements are energized a small red indicator is displayed to the right of the temperature display.



This light will go out when the desired temperature is reached.

The setting of the DHW temperature can be modified by pushing either the  button or the  button and using the same buttons to adjust the setting that flashes on the display. The modified setting will be stored automatically after a few seconds, or instantly by pushing the  button.

The DHW setting can be varied between 20 and 60°C. When Eco Smart is activated, the set-point temperature is reduced during the non-use periods and the word ECO alternates with the DHW setting during the temperature configuration. See "6.12 ECO SMART FUNCTION".

 The DHW has priority over the central heating operation and so the outputs are never added together.

 Water storage at maximum temperature will provide the best protection against the possible formation of legionella bacteria.

### 6.4 CENTRAL HEATING OPERATION



First ensure that any external controls such as room thermostat or time clock are demanding heat.

To select the heating function, push the  button. Pushing again will switch the function off and return display to just a red dot.



When the heating mode is selected the display will show the temperature of the heating water.



We can modify the setting of the temperature of the water by pushing either the  button or the  button and using the same buttons to adjust the value that flashes on the display.

The modified setting will be stored after a few seconds or instantly by pushing the  button.

The heating setting can be varied between 8°C and 85°C. The symbol H appears after the 85 value or before the 8 value. If this value is selected, the heating will function in anti-freeze mode.

If the setting is higher than the actual temperature of the heating water and the DHW is not connected, the heating will connect and a small red indicator of the consumption of heating resistances will light up.





### 6.5 ANTI-FREEZE MODE (Frost Protection)



It is possible to select an anti-freeze mode for frost protection during periods of inactivity. The power supply to the boiler must be maintained.





By attempting to set a central heating temperature below the 8°C value or above the 85°C value the symbol H will appear on the display. By selecting this value the heating will only work in anti-freeze mode i.e. if the boiler temperature falls to 7°C the heating will activate automatically.









### 6.6 USER PARAMETERS

The user can change a number of parameters to set some functions of the boiler to the needs of each customer.



To access the user parameters menu – with front display OFF, press and hold the  and  buttons for at least 5 secs.

To move forward or backward through the menu use the  and  buttons respectively.

To modify a parameter, press the  button and the current value will be displayed. It can be modified with the  and  buttons. Press the  button to validate

	<b>Modulation.</b>	1 (modulation ON) 0 (modulation OFF).
	<b>Units.</b>	°C (Celsius) °F (Fahrenheit).
	<b>Legionella.</b>	1 (Legionella protection ON) 0 (Legionella protection OFF).
	<b>AUTO heating regulation.</b>	If a fan outdoor temperature probe is installed it is possible to activate the auto heating regulation by shifting this parameter value to 1.
	<b>TIMAX.</b>	Maximum water flow temperature in AUTO heating mode.
	<b>TIMIN.</b>	Minimum water flow temperature in AUTO heating mode.
	<b>TEMAX.</b>	Outdoor temperature from which the water flow temperature will be TIMIN.
	<b>TEMIN.</b>	Outdoor temperature below which the water flow temperature will be TIMAX.

Parameters menu from **P16 – P18** are only accessible for DHW & central heating boiler (P00=1).

	<b>ECO SMART.</b>	1 (Eco Smart function ON) 0 (Eco Smart function OFF).
	<b>TCON.</b>	Maintenance consumption connection time. Factory pre-set.
	<b>TSCON.</b>	Time interval between maintenance consumption. Factory pre-set

## 6.7 HEATING MODULATION FEATURE

The advanced control board on the boiler will automatically modulate the heating output to the demand required to save energy.

This function works by the boiler 'learning' and anticipating the time taken to reach the temperature level demanded by the external thermostatic control. The power output is automatically adjusted therefore reducing power consumption on warmer days or when another heat source is present.

An external 'volt free' control must be fitted across the terminals marked 'TA' on the PCB and the 'bridge' removed for this function to be activated.

This feature can be disabled using parameter P11. See "6.6 USER PARAMETERS".

## 6.8 LEGIONELLA PROTECTION

If Legionella protection is activated, once a week the DHW temperature is raised to the maximum allowed if this temperature has not been reached in the last 7 days. By default protection against Legionella it is disabled. This function can be activated with parameter P10. See "6.6 USER PARAMETERS".

## 6.9 AUTO HEATING REGULATION

It is possible to regulate the temperature at which the boiler drives the water heating circuit depending on the outdoors temperature. This method of regulation provides maximum comfort as it anticipates changes in the thermal needs of the house. The room thermostat continues to regulate the temperature inside the house.

To activate this mode of heating, the installer will need to connect an external temperature sensor (not supplied) and activate the P05 and P11 parameters.

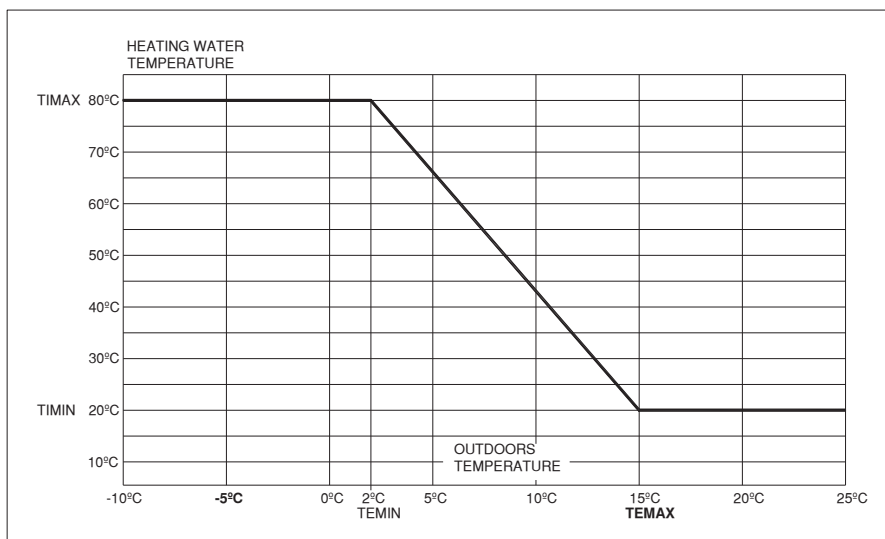

There are four parameters that define this function.

**TIMAX.** Maximum water flow temperature in AUTO heating mode.  
In the above example TIMAX=80°C.





**TIMIN.** Minimum water flow temperature in AUTO heating mode.  
In the above example TIMIN=20°C.

**TEMAX.** Outdoor temperature from which the water flow temperature will be TIMIN.  
In the above example TEMAX=15°C.

**TEMIN.** Outdoor temperature below which the water flow temperature will be TIMAX.  
In the above example TEMIN=2°C.

On the coldest days the water will be driven at higher temperatures and vice versa on the hottest days-less water will be driven at a lower temperature. In the example, we see how, if the outdoors temperature is of 5°C the water flow temperature heating circuit would be about 66 °C.

You can temporarily override the automatically calculated set point. If, for example, you want to use the boiler to the maximum for a few hours even when automatic control mode, you would proceed as follows:

When pressing the  or  button, the display will alternatively show the calculated set point and the indication **AUTO**. By holding down either of these two keys for at least 5 seconds, the calculated set point will start flashing and the set point can now be modified with the same keys. Validate the selection by pressing the  button. The time that the set point is going to be overridden is shown: **1H**. It can be modified from 1 to 24h. Validate the selection by pressing the  button. The override set point and the time remaining are displayed alternatively every 10 seconds. At any time it is possible to cancel this state just by turning off and restarting the boiler.

### 6.10 BLOCKING THE CONTROLS

It is possible to lock the buttons of the control panel to prevent any adjustment.

By keeping the  button pressed down for a few seconds, the control panel will be locked.

The control buttons of the boiler will be locked and no button will respond when pressed. Internally all the settings remain the same and the boiler will function normally.

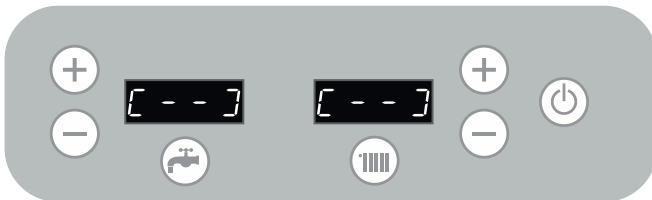

To unlock the buttons, press the same button down for a few seconds until the above displayed symbol goes off. If the boiler is disconnected from the mains or there is a failure in the house's electricity supply, the buttons will also be unlocked.

### 6.11 PUMP ANTI-SEIZE FUNCTION

The advanced boiler control will automatically energize the pump for 10 seconds each month to protect it from seizing during long periods of inactivity. The power supply must be maintained for this function to operate.

### 6.12 ECO SMART FUNCTION

When Eco Smart function activated, the advanced boiler control will automatically adapt the water heating process to the individual usage conditions with the aim of reducing energy consumption. Eco Smart function will study the weekly usage of the DHW and will use this information to get the domestic hot water ready for the periods of use, and to reduce the temperature set-point in the non-use periods minimizing the energy losses and reducing the energy consumption. This function can be activated with parameter P16. See "6.6 USER PARAMETERS".

 The domestic water tank temperature during the non-use periods can be lower than the set-point DHW temperature when Eco Smart function is activated.

## 7.- TROUBLESHOOTING

### 7.1 POSSIBLE FAULTS & SOLUTIONS

Problem	Possible cause	Solution
<b>Boiler will not start</b>	No power to boiler.	Check incoming power supply.
	No power.	Check boiler control switch is on. (See Section 6.1.)
	Heating overheat. Switch tripped.	Locate switch and reset. (See Section 7.2)
	DHW Overheat switch tripped.	Locate switch and reset. (See Section 7.2)
	DHW tank empty.	Check cold water mains is on. Open a hot water tap until the water flows.
<b>Fault E1 displayed</b> Heating flow temperature sensor	Heating water out temperature probe defective.	Contact Technical Service
<b>Fault E2 displayed</b> Heating return temperature sensor	Heating water return temperature probe defective.	Contact Technical Service
<b>Fault E3 displayed</b> Heating system water flow switch	Low heating system pressure.	Check for leaks. Refill heating system to 1.5 bar.
	Pump not turning.	Check rotating freely (sect 5.5) Replace pump if necessary.
	Air in system.	Purge thoroughly. Check automatic air valve open. Vent pump (sect 5.5)
	System resistance too high or blockage.	Check pump speed 3. Check pump duty (sect 4.9b) Open all radiator valves. Install system by-pass.
<b>Fault E6 displayed</b> DHW temperature sensor	Defective DHW tank temperature sensor.	Check connections. Replace sensor if necessary.
<b>Fault E8 displayed</b> Outdoor temperature sensor	Defective outdoor temperature sensor or not present.	This sensor is optional. Check connections. Replace sensor if necessary. Check parameter settings correct (Sect 5.1)
<b>Heating system water discharging from 3 bar safety valve</b>	Excessive heating system pressure.	Check filling loop has not been left connected and is not "letting water pass". Disconnect filling loop hose. Check expansion vessel is charged to correct level with air. Check system expansion volume.
<b>Domestic water discharging from 7 bar valve</b>	Excessive pressure in domestic water system.	Check group combination inlet valve is fitted. Install if not fitted. Check incoming mains pressure to boiler is below 3 bar. Check expansion vessel is charged to correct level with air.
The buttons do not respond	Control panel blocked	See Section 6.10 BLOCKING THE CONTROLS
Low heating temperature	Settings too low.	Check temperature & output selected.
	Failure of heating elements	Check and replace.
	Heat requirements miscalculated.	Re-calculate & configure.

If the suggested action fails to resolve a problem, please contact **ELNUR** technical service for further advice.

## 7.2 OVERHEAT LOCK-OUT & RE-SETTING

### Central heating overheat.

If the boiler detects a overheat condition of 100°C (80°C if adapted floor heating) in the central heating circuit a safety thermal limit switch will operate and switch the boiler off disabling all functions including DHW production. The cause of the overheat should be investigated.

The safety limit switch is on the right underside of the boiler and will require re-setting manually by following the procedure shown:

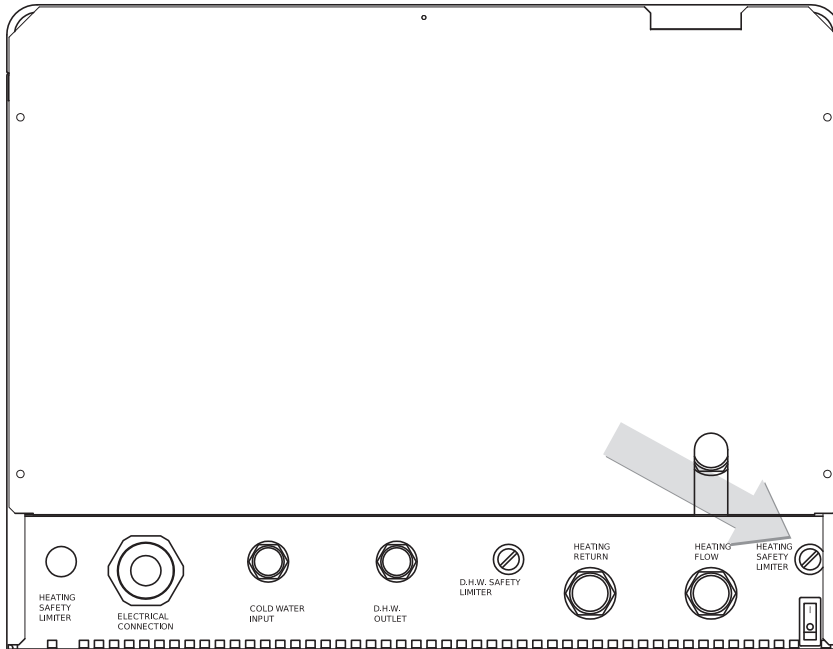

Unscrew & remove the black cap and push the small pin behind it until you hear a click. The limiter will not re-set until the temperature in the heating header drops below 100°C or 80°C if the boiler is adapted for radiant floor heating.

### Domestic Hot Water overheat.

As with the heating circuit a second thermal limit switch, situated on the left underside of the boiler, will operate if a overheat condition (80°C) is detected in the DHW circuit and switch the boiler off disabling all functions including central heating.

The cause should be investigated and the above procedure followed to re-set the DHW limit switch.

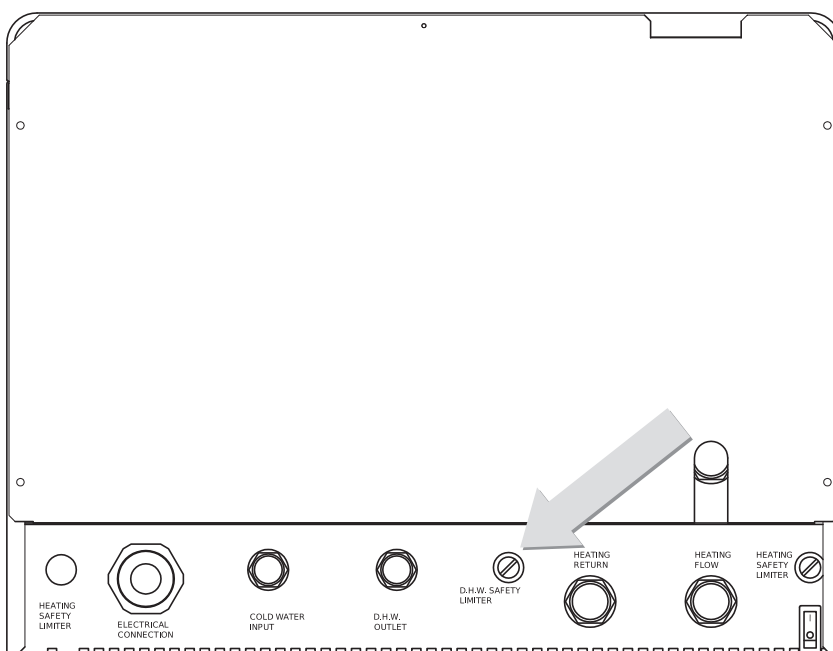

### 7.3 HEATING SYSTEM FLOW SWITCH – E3 ERROR & SYSTEM BY-PASS REQUIREMENTS

If the error E3 appears on the display, the flow switch has detected insufficient water flow in the heating circuit and heat production is disabled to protect the boiler from overheating.



The possible causes for this condition are:

- Insufficient water pressure in the heating system requiring re-filling to 1.5bar
- Pump not circulating or seized. Check as shown (Sect 5.3)
- Blockage in heating circuit from debris or a foreign object in the boiler or pipe-work.
- Insufficient flow rate caused by restrictions such as insufficient size pipe-work, too many bends or isolation valves with restricted bore.
- Closed radiator valves (Thermostatic). In this situation, it is essential the required minimum flow rate of 7 L/min is maintained through the boiler during all conditions. It may be sufficient to maintain one radiator with permanently open valves however the guidance under current Building Regulations relating to the conservation of energy recommends the fitting of an automatic by-pass valve. This type of valve modulates open when necessary to ensure that the appropriate minimum flow rate is maintained through the boiler, at all other times it is closed thus preventing unnecessary and wasteful circulation through the bypass and the boiler.

### 7.4 CHECKING RATED HEAT OUTPUT



It is possible to check the actual heat power output configuration that is set on the boiler and also the modulated operating output at that moment.



Press the button for three seconds.

The heating display will show  followed by the temperature value of the return probe of the heating circuit.



On pushing the button, the display will show  followed by the value of the limited maximum output according to the tables (see 5.1).



On pushing the button again, the display will show  followed by the actual modulated output power at that moment.

## 8.- MAIN COMPONENTS LIST

Heating expansion vessel 6L	ref. 60091510	DHW. resistance joint	ref. 60105671
DHW. expansion vessel 3L	ref. 60105582	Heating resistance joint	ref. 60091090
DHW. expansion vessel hose MAC	ref. 60101951	¾" heating flow detector	ref. 60100805
53 L DHW. insulated tank	ref. 60105565	0-4 bar pressure gauge	ref. 60100820
Insulated heating header tank	ref. 60101701	100°C thermal limiter	ref. 60101860
Circulation pump RKC130	ref. 60190076	80°C thermal limiter	ref. 60101870
Main electronic PCB MAC	ref. 60105585	Automatic purge	ref. 60091280
Power PCB MAC with support	ref. 60105595	3 bar central heating relief valve	ref. 60100845
Temperature sensor white	ref. 60105600	7 bar 90°C DHW. P&T relief valve	ref. 60105665
Temperature sensor black	ref. 60105605	½" filling / shut off valve	ref. 60105686
15 kW heating resistance & joint 140	ref. 60100750	Keyboard MAC	ref. 60105555
15 kW DHW. resistance & joint	ref. 60100700		

## 9.- MAINTENANCE & CARE

Gabarron MATTIRA electric combi boilers will require an annual maintenance check to ensure preservation of the manufacturer's warranty and a prolonged and trouble-free life. A full check list and service log is located at the back of this manual which, should be adhered to. The following points below should also be constantly observed:

- Check and maintain the heating system pressure between 1 & 1.5 bar when cold. Frequent re-filling of the system could cause scaling and corrosion and should be avoided. Regular pressure loss could indicate a leak and should be investigated promptly.



CAUTION – Under no circumstances should the boiler be switched on when the system is dry.



CAUTION - Never start the boiler when the DHW tank is empty; to fill it for the first time open a hot water tap and wait until water comes out of it.

- Keep the ventilation openings on the boiler clear to ensure correct operation and protect from overheating. Do not place or store objects on the boiler.
- Protect against freezing by ensuring power is maintained to the boiler at all times, unless the water supply is interrupted or the heating system is empty. In dwellings, frequently un-occupied or at risk of freezing, an appropriate anti-freeze can be added to the heating system at a concentration of not more than 30% by volume. Otherwise it is recommended to isolate the power and completely drain the heating and hot water systems.
- The outer case can be cleaned with a damp cloth having first isolated the boiler from the mains. Do not use solvents or abrasive cleaners.

## 10.- ENVIRONMENTAL INFORMATION

Gabarrón boilers are manufactured within a certified environmental management system. From the design stage, all the production phases are performed taking into account the most rigorous environmental requirements. For example, the selection of materials involves guaranteeing their biodegradability, re-use and recycling.

When this boiler's long, useful life is over; it must be handed in to an electrical equipment collection point for proper recycling. By ensuring that this product is correctly disposed of, you will help to avoid any possible negative effects on the environment and public health that could occur if this product is not properly handled. To obtain more detailed information on the recycling of this product, contact your local authority, your waste disposal service or the shop where you purchased the product.

These regulations only apply in EU member countries.



## II.- TECHNICAL DATA

		MAC15C
Frequency	Hz	50
<b>Connection 3x400V+N~</b>		◆
Output limited to <b>15kW</b> ; Maximum intensity	A	21.7
Output limited to <b>13kW</b> ; Maximum intensity	A	21.7
Output limited to <b>12kW</b> ; Maximum intensity	A	21.7
Output limited to <b>11kW</b> ; Maximum intensity	A	21.7
Output limited to <b>10kW</b> ; Maximum intensity	A	21.7
Output limited to <b>9kW</b> ; Maximum intensity	A	13.0
Output limited to <b>8kW</b> ; Maximum intensity	A	13.0
Output limited to <b>7kW</b> ; Maximum intensity	A	13.0
Output limited to <b>6kW</b> ; Maximum intensity	A	13.0
Output limited to <b>5kW</b> ; Maximum intensity	A	13.0
Output limited to <b>4kW</b> ; Maximum intensity	A	13.0
Output limited to <b>3kW</b> ; Maximum intensity	A	13.0
<b>Connection 230V~ single phase</b>		◆ <sup>1</sup>
Nominal maximum intensity <b>15kW</b>	A	65.2 <sup>1</sup>
Maximum converted intensity at <b>13kW</b>	A	56.5 <sup>1</sup>
Maximum converted intensity at <b>12kW</b>	A	52.2
Maximum converted intensity at <b>11kW</b>	A	47.8
Maximum converted intensity at <b>10kW</b>	A	43.5
Maximum converted intensity at <b>9kW</b>	A	39.1
Maximum converted intensity at <b>8kW</b>	A	34.8
Maximum converted intensity at <b>7kW</b>	A	30.4
Maximum converted intensity at <b>6kW</b>	A	26.1
Maximum converted intensity at <b>5kW</b>	A	21.7
Maximum converted intensity at <b>4kW</b>	A	17.4
Maximum converted intensity at <b>3kW</b>	A	13.0
DHW available time with <b>15kW</b>	min	5'49"
DHW available time with <b>13kW</b>	min	6'42"
DHW available time with <b>12kW</b>	min	7'16"
DHW available time with <b>11kW</b>	min	7'56"
DHW available time with <b>10kW</b>	min	8'43"
DHW available time with <b>9kW</b>	min	9'41"
DHW available time with <b>8kW</b>	min	10'54"
DHW available time with <b>7kW</b>	min	12'27"
DHW available time with <b>6kW</b>	min	14'32"
DHW available time with <b>5kW</b>	min	17'26"
DHW available time with <b>4kW</b>	min	21'48"
DHW available time with <b>3kW</b>	min	29'04"
DHW available time with <b>2kW</b>	min	43'36"
Weight	kg	72
Maximum Pressure of the Heating circuit	bar	2.5
Maximum operating temperature (Heating Circuit)	°C	85
Maximum operating temperature (DHW)	°C	60
Maximum Design Pressure DHW	bar	6
Heat Loss at 65°C	kWh/24h	1.01
Insulated steel heater header		◆
53 L stainless steel insulated DHW store	No CFC	◆
Stainless steel plated resistance elements INCOLOY800	DHW	◆
Stainless steel plated resistance elements INCOLOY800	Heating	◆
6 litre expansion vessel		◆
DHW 3 litre expansion vessel		◆
Electronic regulation of heater modulation		◆
Electronic regulation DHW		◆
Eco Smart Function		◆
Digital display		◆
0-4 bar pressure gauge		◆
Accelerator pump		◆
Automatic purge		◆
TRIACS silent power switches		◆
Heating flow detector		◆
100°C heating temperature limiter		◆
80°C DHW temperature limiter		◆
3 bar central heating relief valve		◆
7 bar DHW Pressure and Temperature relief valve		◆
DHW retention valve		◆
Ambient thermostat intake		◆
Anti-electrolysis DHW hoses.		◆
Sound power level (LWA)	dB	36

◆ included

<sup>1</sup> using connecting links included



## DECLARACION DE CONFORMIDAD

De acuerdo con la norma ISO / IEC 17050-1

## DECLARATION OF CONFORMITY

According to the Standard ISO / IEC 17050-1

Nº 67315005

**Nombre del fabricante :** ELNUR, S.A.  
**Manufacturer's name :**

**Dirección del fabricante :** ELNUR, S.A.  
**Manufacturer's address :** P.I. El Nogal. Villa Esther, 11  
28110 Algete, Madrid, Spain

**Declara que el producto :** Caldera modulante digital de calefacción y A.C.S. "MATTIRA"  
**Declares, that the product :** "MATTIRA" Heating and D.H.W. digital modulating boiler

**Marca :** GABARRÓN  
**Trade Mark :**

**Modelos :** MAC15C  
**Models :**

**ha sido fabricado conforme a las especificaciones técnicas del producto y cumple en todo las Normas vigentes, en particular:**  
**has been manufactured to the technical specifications of the product and conforms in all respects to the relevant standards and regulations in force and especially to :**

**Seguridad :** EN 60335-1:2012+A11:2014+A12:2017+A13:2017  
**Safety :** EN 60335-2-35:2016  
EN 60335-2-21:2003+A1:2005+A2:2008  
EN 50106:2008

**EMC :** EN 55014-1:2006+A1:2009+A2:2011  
EN 55014-2:2015  
EN 61000-3-2:2014  
EN 61000-3-3:2013

**Información adicional :**  
**Additional information :**

El producto aquí citado lleva el marcado CE y se halla en conformidad con la Directiva de Ecodiseño 2009/125/CE, la Directiva de Baja Tensión 2014/35/UE y la Directiva de EMC 2014/30/UE.

Cualquier uso que no esté de acuerdo con las instrucciones y/o cualquier cambio al aparato invalidarán esta declaración de conformidad.

*The product herewith carries the CE mark and complies with the requirements of Ecodesign Directive 2009/125/EC, the Low Voltage Directive 2014/35/UE and EMC Directive 2014/30/UE.*

*Any use not according to the instructions and/or any change to the appliance will invalidate this declaration of conformity.*

Algete, 01 de Marzo de 2019

Place, Date

**Fdo.** Alberto Fernández  
Director Gerente  
ELNUR, S.A.

MODEL(S): <b>GABARRON MATTIRA MACI5C</b> (wall mounted electric combination boiler)
CONDENSING BOILER: NO
LOW TEMP. BOILER: NO
BI BOILER: NO
CO-GENERATION SPACE HEATER: NO
COMBINATION HEATER: YES

Information	Symbol	Value	Unit
<b>Space heating:</b>			
Rated heat output	Prated	15	kW
Power output	P4	14,812	kW
Seasonal space heating energy efficiency	$\eta_s$	36,4	%
Useful efficiency at rated heat output and high-temperature regime	$\eta_4$	39,5	%
Auxiliary electricity consumption in standby mode	Psb	0,003	kW
Standby heat loss	Pstby	0,07	kW
Sound power level, indoors	LWA	36	dB
Seasonal space heating energy efficiency class	D		
<b>Water heating:</b>			
Declared load profile	L		
Daily energy consumption	Qelec	13,01	kWh/día
Annual electricity consumption	AEC	2733	kWh
Water heating energy efficiency	$\eta_{wh}$	37,5	%
Water heating energy efficiency class	C		
Contact details:	ELNUR, S.A. Travesía de Villa Esther, 11 28110 – Algete (Madrid) Spain		

## 14.- WIRING DIAGRAMS

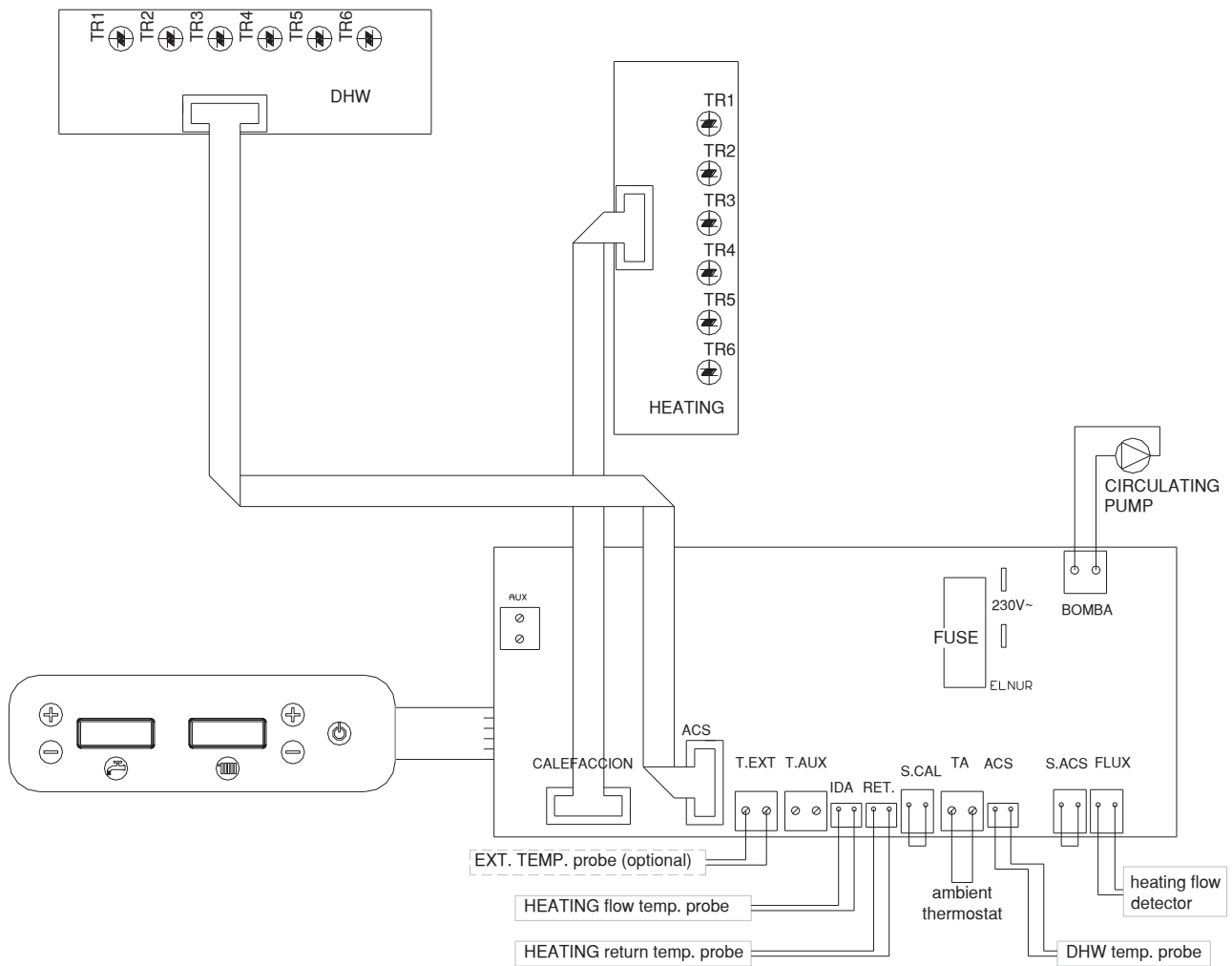

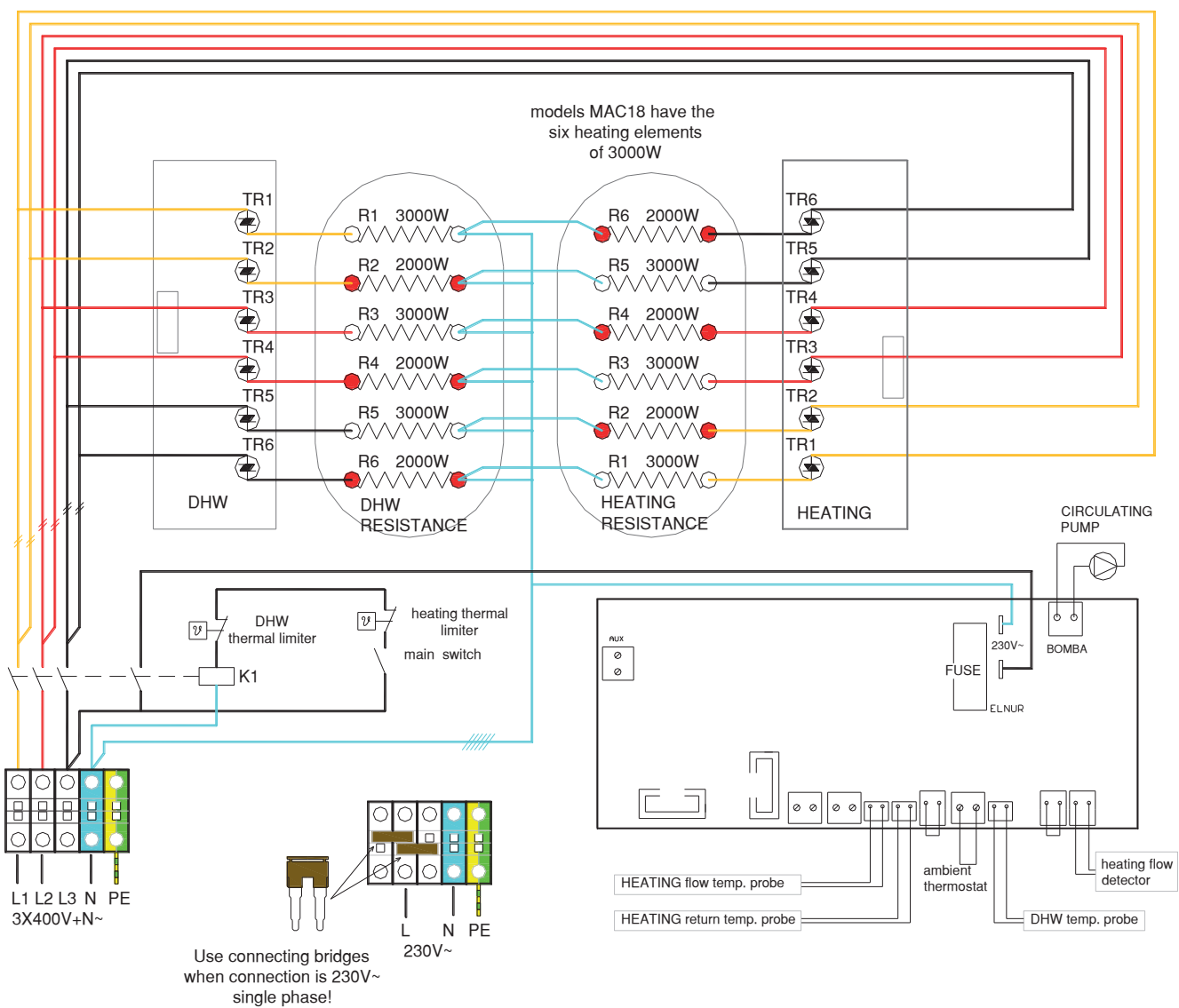

## 15.- WARRANTY

Your new Gabarron Mattira electric combi boiler from Elnur is warranted against faulty materials and manufacture defects. The internal unvented hot water cylinder is warranted against faulty materials and manufacture defects for a period of 5 years from the date of purchase. The remainder of components is warranted against faulty materials and manufacture defects for a period of 2 years from the date of purchase.

The above warranty is provided on the basis that:

- The boiler has been installed in accordance with the guidance detailed in this user manual and all relevant Codes of Practice and Regulations that are in force at the time of installation.
- All necessary valves, fittings, safety valves and controls have been installed.
- Installation has been completed by a competent person with regard to heating installation, G3 of the Building Regulations, Water Regulations/Bylaws and Electrical Regulations.
- No unauthorized person or person without prior written agreement by Elnur UK Ltd has modified or altered the boiler in any way whatsoever.
- The installation commissioning checklist (Section 16 at the rear of this manual) has been completed.
- The boiler has been regularly maintained as detailed in this manual (Section 9).
- The maintenance checklist (Section 17) is verified in the service record (Section 18) and that the service record is up to date.
- The boiler is only being used for domestic heating and hot water purposes.
- The boiler has been installed in the UK or Ireland.
- The warranty card supplied separately with this manual is completed and returned to Elnur UK Ltd or that the online guarantee registration form is completed and submitted at [www.elnur.co.uk](http://www.elnur.co.uk) within 21 days of purchase.

Important Note:

The Gabarron Mattira electric combi boiler is not warranted against the effects of damage caused by frost.

The heating elements are not warranted against the effects of damage caused by scale.

This warranty is in addition to the statutory rights of the consumer and in no way affects the statutory rights of the consumer.

### **Elnur UK Limited Contact Information**

**Pre-sales product & installation advice – [advice@elnur.co.uk](mailto:advice@elnur.co.uk) / 01438 358760**

**Product specification service / advice – [projects@elnur.co.uk](mailto:projects@elnur.co.uk) / 01438 358760**

**Technical issues during installation – [technical@elnur.co.uk](mailto:technical@elnur.co.uk) / 01942 265048**

**After-sales service – [technical@elnur.co.uk](mailto:technical@elnur.co.uk) / 01942 265048**

## 16.- INSTALLATION COMMISSIONING CHECKLIST

### 16.1 HOT WATER STORAGE SYSTEM

This Commissioning Checklist is to be completed in full by the competent person who commissioned the heating system as a means of demonstrating compliance with the appropriate Building Regulations and then handed to the customer to keep for future reference.

Failure to install and commission this equipment to the manufacturer's instructions may invalidate the warranty but does not affect statutory rights.

Customer name:										Telephone number:															
Address:																									
Boiler Make and Model: <b>Gabarron Mattira MAC 15C electric combi boiler</b>																									
Boiler Serial Number																									
Commissioned by (PRINT NAME)										Registered Operative ID Number															
Company name:										Telephone number:															
Company address:																									
										Commissioning date:															
To be completed by the customer on receipt of a Building Regulations Compliance Certificate*:																									
Building Regulations Notification Number (if applicable)																									
ALL INSTALLATIONS																									
What is the incoming static cold water pressure at the inlet to the system?																				bar					
Has a strainer been cleaned of installation debris (if fitted)?															Yes				No						
Is the installation in a hard water area (above 200ppm)?															Yes				No						
If yes, has a water scale reducer been fitted?															Yes				No						
What type of scale reducer has been fitted?																									
What is the hot water thermostat set temperature?																				°C					
What is the maximum hot water flow rate at set thermostat temperature (measured at high flow outlet)?																				l/min					
Time and temperature controls have been fitted in compliance with Part L of the Building Regulations?															Yes										
Type of control system (if applicable)															Y plan				S Plan				Other		
What is the hot water temperature at the nearest outlet?																				°C					
All the appropriate pipes have been insulated up to 1 metre or the point where they become concealed															Yes										
Where is the pressure reducing valve situated (if fitted)?																									
What is the pressure reducing valve setting?																				bar					
Has a combined temperature and pressure relief valve and expansion valve been fitted and discharge tested?															Yes				No						
The tundish and discharge pipework have been connected and terminated to Part G of the Building Regulations															Yes										
Are all energy sources fitted with a cut out device?															Yes				No						
Has the expansion vessel or internal air space been checked?															Yes				No						
The hot water system complies with the appropriate Building Regulations															Yes										
The system has been installed and commissioned in accordance with the manufacturer's instructions															Yes										
The system controls have been demonstrated to and understood by the customer															Yes										
The manufacturer's literature, including Installation Checklist and Service Record, has been explained and left with the customer															Yes										
Commissioning Engineer's Signature																									
Customer's Signature																									
(To confirm satisfactory demonstration and receipt of manufacturer's literature)																									

\*All installations in England and Wales must be notified to Local Authority Building Control (LABC) either directly or through a competent persons Scheme. A Building Regulations Compliance Certificate will then be issued to the customer.

## 16.2 CENTRAL HEATING SYSTEM

This Commissioning Checklist is to be completed in full by the competent person who commissioned the heating system as a means of demonstrating compliance with the appropriate Building Regulations and then handed to the customer to keep for future reference.

Failure to install and commission this equipment to the manufacturer's instructions may invalidate the warranty but does not affect statutory rights.

Commissioned by (PRINT NAME)		Registered Operative ID Number	
Company name:		Telephone number:	
Company address:			
		Commissioning date:	
To be completed by the customer on receipt of a Building Regulations Compliance Certificate*:			
Building Regulations Notification Number (if applicable)			
<b>ALL INSTALLATIONS</b>			
What is the heating water thermostat set temperature?			°C
Time and temperature controls have been fitted in compliance with Part L of the Building Regulations?			Yes
Type of control system (if applicable)	Y plan	S Plan	Other
If "other" selected above, please provide details			
Boiler interlock			Provided
Thermostatic radiator valves	Fitted?		Not required?
Automatic bypass to system	Fitted?		Not required?
All appropriate pipes have been insulated up to 1 metre or the point where they become concealed			Yes
Has the heating system discharge been connected and terminated correctly?			Yes
The system has been flushed and cleaned in accordance with BS7593 and boiler manufacturer's instructions?			Yes
What system cleaner was used?			
What inhibitor was used?	Quantity		Litres
Central heating flow temperature?	Degrees		°C
Central heating return temperature?	Degrees		°C
Are all energy sources fitted with a cut out device?	Yes		No
Has the expansion vessel or internal air space been checked?	Yes		No
The system has been installed and commissioned in accordance with the manufacturer's instructions			Yes
The system controls have been demonstrated to and understood by the customer			Yes
The manufacturer's literature, including Installation Checklist and Service Record, has been explained and left with the customer			Yes
Commissioning Engineer's Signature			
Customer's Signature			
(To confirm satisfactory demonstration and receipt of manufacturer's literature)			

\*All installations in England and Wales must be notified to Local Authority Building Control (LABC) either directly or through a competent persons Scheme. A Building Regulations Compliance Certificate will then be issued to the customer.



### 16.3 ELECTRICAL INSTALLATION

This Commissioning Checklist is to be completed in full by the competent person who commissioned the heating system as a means of demonstrating compliance with the appropriate Building Regulations and then handed to the customer to keep for future reference.

Failure to install and commission this equipment to the manufacturer’s instructions may invalidate the warranty but does not affect statutory rights.

Commissioned by (PRINT NAME)		Registered Operative ID Number	
Company name:		Telephone number:	
Company address:			
		Commissioning date:	
To be completed by the customer on receipt of a Building Regulations Compliance Certificate*:			
Building Regulations Notification Number (if applicable)			
<b>ALL INSTALLATIONS</b>			
Is the electrical supply to the property	single?		three phase?
What is the rating of the main fuse to the property?			Amps
Is the circuit relating to the boiler power supply a dedicated circuit that only supplies the boiler?			Yes
Is the boiler circuit protected by an RCD?			Yes
What is the rating of the boiler circuit MCB?			Amps
What size Twin & Earth cable has been used for the boiler circuit?			mm <sup>2</sup>
Has a “local” isolation switch been installed in close proximity to the boiler?			Yes
What is the rating of the local isolation switch for the boiler circuit?			Amps
If external controls have been installed, are these powered from a separate switched and fused spur?			Yes
Have all electrical connections been checked for tightness including factory connections to main terminals and contactor?			Yes
Has the power setting on the boiler been adjusted to suit the installation requirements and within the capability of the power supply?			Yes
What kW power rating has the boiler been set to?			kW
Has a clamp meter test been carried out to verify the power rating?	Yes		No
Has the electrical installation been tested and certified?			Yes
The system has been installed and commissioned in accordance with the manufacturer’s instructions			Yes
The system controls have been demonstrated to and understood by the customer			Yes
The manufacturer’s literature, including Installation Checklist and Service Record, has been explained and left with the customer			Yes
Commissioning Engineer’s Signature			
Customer’s Signature			
(To confirm satisfactory demonstration and receipt of manufacturer’s literature)			

\*All installations in England and Wales must be notified to Local Authority Building Control (LABC) either directly or through a competent persons Scheme. A Building Regulations Compliance Certificate will then be issued to the customer.

## 17.- MAINTENANCE CHECKLIST

This Maintenance Checklist is to be verified in full by the competent person undertaking the annual service of the boiler. Failure to maintain this equipment to the manufacturer’s instructions may invalidate the warranty but does not affect statutory rights.

<b>PERIODIC MAINTENANCE OF THIS EQUIPMENT IS ESSENTIAL FOR SAFETY &amp; PRESERVATION OF THE MANUFACTURER'S GUARANTEE.</b>	
<b>GENERAL</b>	
Check location of boiler and that it is accessible	
Check that boiler ventilation areas are not blocked or covered	
Visual inspection of appliance for damage or signs or misuse	
Remove boiler casings and inspect / clean	
<b>MAINS PRESSURE HOT WATER STORAGE SYSTEM</b>	
Check and clean filter	
Manually check the operation of the temperature relief valve	
Manually check the operation of the expansion relief valve	
Check discharge pipes from temperature and expansion relief valves are free from obstruction and blockage and are not passing any water	
Check the condition and if necessary descale the heat exchangers in hard water areas	
Check that water pressure downstream of the pressure reducing valve is within the manufacturer’s limits	
Check temperature set point is correct	
Check the pressure on the air side of the expansion vessel. This must be done when the volume in the cylinder is cold	
Check and advise the householder not to place any clothing or other combustible materials against or on top of this appliance	
Complete the service record log	
<b>CENTRAL HEATING SYSTEM</b>	
Check and clean / replace any external filter system fitted in connection with the boiler	
Manually check the operation of the heating 3 bar relief valve	
Check discharge pipe from heating 3 bar relief valve is free from obstruction and blockage and is not passing any water	
Check that the temperature set point is correct	
Check the pressure on the air side of the heating expansion vessel. This must be done when the volume in the heating chamber is cold	
Check pressure gauge is between 1 and 1.5 bar when cold. Top up if required.	
Check quality of heating system water in accordance with inhibitor manufacturers guidelines	
Check boiler visually for leaks and corrosion	
Run boiler to ensure correct operation	
Check for air in system and remove. Top up pressure afterwards as required	
Check operation of any external controls connected to the boiler	
Check and advise the householder not to place any clothing or other combustible materials against or on top of this appliance	
Complete the service record log	
<b>ELECTRICAL</b>	
Check power rating of boiler	
Confirm power rating of boiler is suitable for electrical installation	
Check operation of RCD, MCB and local isolation switch	
Check tightness of all circuit electrical connections	
Check tightness of all power connections to boiler terminals	
Check tightness of all factory connections to main terminals and contactor	
Using a clamp meter, verify the power being drawn by the boiler is relative to the boiler power setting when operating at full demand	
Check and advise the householder not to place any clothing or other combustible materials against or on top of this appliance	
Complete the service record log	
The manufacturer’s literature, including Installation Checklist and Service Record, has been explained and left with the customer	Yes

## 18.- SERVICE RECORD

It is recommended that your Gabarron Mattira boiler is serviced regularly and that the appropriate service record is completed.

Before completing the appropriate service record below, please ensure you have carried out the service as described in the manufacturer's instructions.

SERVICE RECORD #01		DATE:	
General/Heating	Mains pressure Hot Water	Electrical	
Engineer name:			
Company name:			
Telephone No:			
Comments:			
Signature:			

SERVICE RECORD #02		DATE:	
General/Heating	Mains pressure Hot Water	Electrical	
Engineer name:			
Company name:			
Telephone No:			
Comments:			
Signature:			

SERVICE RECORD #03		DATE:	
General/Heating	Mains pressure Hot Water	Electrical	
Engineer name:			
Company name:			
Telephone No:			
Comments:			
Signature:			

SERVICE RECORD #04		DATE:	
General/Heating	Mains pressure Hot Water	Electrical	
Engineer name:			
Company name:			
Telephone No:			
Comments:			
Signature:			

SERVICE RECORD #05		DATE:	
General/Heating	Mains pressure Hot Water	Electrical	
Engineer name:			
Company name:			
Telephone No:			
Comments:			
Signature:			

SERVICE RECORD #06		DATE:	
General/Heating	Mains pressure Hot Water	Electrical	
Engineer name:			
Company name:			
Telephone No:			
Comments:			
Signature:			

SERVICE RECORD #07		DATE:	
General/Heating	Mains pressure Hot Water	Electrical	
Engineer name:			
Company name:			
Telephone No:			
Comments:			
Signature:			

SERVICE RECORD #08		DATE:	
General/Heating	Mains pressure Hot Water	Electrical	
Engineer name:			
Company name:			
Telephone No:			
Comments:			
Signature:			

SERVICE RECORD #09		DATE:	
General/Heating	Mains pressure Hot Water	Electrical	
Engineer name:			
Company name:			
Telephone No:			
Comments:			
Signature:			

SERVICE RECORD #10		DATE:	
General/Heating	Mains pressure Hot Water	Electrical	
Engineer name:			
Company name:			
Telephone No:			
Comments:			
Signature:			



El símbolo en el producto o en su embalaje indica que este producto no se puede tratar como desperdicios normales del hogar. Este producto se debe entregar al punto de recolección de equipos eléctricos y electrónicos para reciclaje. Al asegurarse de que este producto se deseché correctamente usted ayudará a evitar posibles consecuencias negativas para el ambiente y la salud pública, lo cual podría ocurrir si este producto no se manipula de forma adecuada. Para obtener información más detallada sobre el reciclaje de este producto, póngase en contacto con la administración de su ciudad, con su servicio de desechos del hogar o con la tienda donde compró el producto. Estas disposiciones solamente son válidas en los países miembros de la UE.

The symbol on the product or in its packaging indicates that this product may not be treated as household waste. Instead it shall be handed over to the applicable collection point for the recycling of electrical and electronic equipment. By ensuring this product is disposed of correctly, you will help prevent potential negative consequences for the environment and human health, which could otherwise be caused by inappropriate waste handling of this product. For more detailed information about recycling of this product, please contact your local council office, your household waste disposal service or the shop where you purchased the product. These instructions are only valid in the EU member states.

**Supplier:**

ELNUR UK Ltd.  
Unit 1, Brown Street North  
Leigh, Lancashire, WN7 1BU.  
+44(0)1942 670119  
info@elnur.co.uk

**Manufactured by:**

ELNUR S.A.  
Travesía de Villa Esther, 11 28110, Algete  
Madrid Telephone: +34 916281440

15190020 R2 | EN

[www.elnur.co.uk](http://www.elnur.co.uk)



ER-0706/1999



GA-2006/0284



© All rights reserved. As part of the continuous improvement policy, ELNUR, S.A. reserves the right to alter or modify any specifications without notice.